

PHILIPS

Monitor

1000 Series



27E1N1800AE
27E1N1900AE

EN

User manual	1
Customer care and warranty	23
Troubleshooting and FAQs	27

Table of Contents

1. Important
1.1 Safety precautions and maintenance
1.2 Notational Descriptions
1.3 Disposal of product and packaging material
2. Setting up the monitor
2.1 Installation
2.2 Operating the monitor
2.3 Remove the Base Assembly for VESA Mounting
3. Image Optimization
3.1 SmartImage
3.2 SmartContrast
4. Power Delivery and Smart Power (27E1N1900AE)
5. Adaptive Sync
6. HDR
7. Technical Specifications
7.1 Resolution & Preset Modes
8. Power Management
9. Customer care and warranty
9.1 Philips' Flat Panel Monitors Product Defect Policy
9.2 Customer Care & Warranty
10. Troubleshooting & FAQs
10.1 Troubleshooting
10.2 FAQs

1. Important

This electronic user's guide is intended for anyone who uses the Philips monitor. Take time to read this user manual before you use your monitor. It contains important information and notes regarding operating your monitor.

The Philips guarantee applies provided the product is handled properly for its intended use, in accordance with its operating instructions and upon presentation of the original invoice or cash receipt, indicating the date of purchase, dealer's name and model and production number of the product.

1.1 Safety precautions and maintenance

Warnings

Use of controls, adjustments or procedures other than those specified in this documentation may result in exposure to shock, electrical hazards and/or mechanical hazards.

Read and follow these instructions when connecting and using your computer monitor.

Excessive sound pressure from earphones and headphones can cause hearing loss. Adjustment of the equalizer to maximum increases the earphones and headphones output voltage and therefore the sound pressure level.

Operation

- Please Keep the monitor out of direct sunlight, very strong bright lights and away from any other heat source. Lengthy exposure to this type of environment may result in discoloration and damage to the monitor.

- Keep the display away from oil. Oil may damage the plastic cover of the display and void the warranty.
- Remove any object that could fall into ventilation holes or prevent proper cooling of the monitor's electronics.
- Do not block the ventilation holes on the cabinet.
- When positioning the monitor, make sure the power plug and outlet are easily accessible.
- If turning off the monitor by detaching the power cable or DC power cord, wait for 6 seconds before attaching the power cable or DC power cord for normal operation.
- Please use approved power cord provided by Philips all the time. If your power cord is missing, please contact with your local service center. (Please refer to Service contact information listed in Important information manual.)
- Operate under the specified power supply. Be sure to operate the monitor only with the specified power supply. Use of an incorrect voltage will cause malfunction and may cause fire or electric shock.
- Protect the cable. Do not pull or bend the power cable and signal cable. Do not place the monitor or any other heavy objects on the cables, if damaged, the cables may cause fire or electric shock.
- Do not subject the monitor to severe vibration or high impact conditions during operation.
- To avoid potential damage, for example the panel peeling from the bezel, ensure that the monitor does not tilt downward by more than -5 degrees. If the -5 degree downward tilt angle maximum is exceeded, the

monitor damage will not be covered under warranty.

- Do not knock or drop the monitor during operation or transportation.
- Excessive usage of monitor can cause eye discomfort, it's better to take shorter breaks more often at your workstation than longer breaks and less often; for example a 5-minute break after 50-60-minute continuous screen use is likely to be better than a 15-minute break every two hours. Try to keep your eyes from eye strain while using screen for a constant period of time by:
 - Looking at something varying distances after a long period focusing on the screen.
 - Conscious Blinking often when you work.
 - Gently closing and rolling your eyes to relax.
 - Reposition your screen to appropriate height and angle according to your height.
 - Adjusting the brightness and contrast to appropriate level.
 - Adjusting the environment lighting similar to that of your screen brightness, avoid the fluorescent lighting, and surfaces that do not reflect too much light.
 - Seeing a doctor if your symptoms.

Maintenance

- To protect your monitor from possible damage, do not put excessive pressure on the LCD panel. When moving your monitor, grasp the frame to lift; do not lift the monitor by placing your hand or fingers on the LCD panel.

display unchanging static content. Uninterrupted display of still or static images over an extended period may cause “burn-in”, also known as “after-imaging” or “ghost imaging”, on your screen.

- “Burn-in”, “after-imaging”, or “ghost imaging” is a well-known phenomenon in LCD panel technology. In most cases, the “burn-in” or “after-imaging” or “ghost imaging” will disappear gradually over a period of time after the power has been switched off.

Warning

Failure to activate a screen saver, or a periodic screen refresh application may result in severe “burn-in” or “after-image” or “ghost image” symptoms that will not disappear and cannot be repaired. The damage mentioned above is not covered under your warranty.

Service

- The casing cover should be opened only by qualified service personnel.
- If there is any need for any document for repair or integration, please contact with your local service center. (Please refer to Service contact information listed in Important information manual.)
- For transportation information, please refer to “Technical Specifications”.
- Do not leave your monitor in a car/trunk under direct sun light.

Note

Consult a service technician if the monitor does not operate normally, or you are not sure what procedure to take when the operating instructions given in this manual have been followed.

1.2 Notational Descriptions

The following subsections describe notational conventions used in this document.

Notes, Cautions and Warnings

Throughout this guide, blocks of text may be accompanied by an icon and printed in bold or italic type. These blocks contain notes, cautions or warnings. They are used as follows:

Note

This icon indicates important information and tips that help you make better use of your computer system.

Caution

This icon indicates information that tells you how to avoid either potential damage to hardware or loss of data.

Warning

This icon indicates the potential for bodily harm and tells you how to avoid the problem.

Some warnings may appear in alternate formats and may not be accompanied by an icon. In such cases, the specific presentation of the warning is mandated by the relevant regulatory authority.

1.3 Disposal of product and packing material

Waste Electrical and Electronic Equipment-WEEE



This marking on the product or on its packaging illustrates that, under European Directive 2012/19/EU governing used electrical and electronic appliances, this product may not be disposed of with normal household waste. You are responsible for disposal of this equipment through a designated waste electrical and electronic equipment collection. To determine locations for dropping off such waste electrical and electronic, contact your local government office, the waste disposal organization that serves your household or the store at which you purchased the product.

Your new monitor contains materials that can be recycled and reused. Specialized companies can recycle your product to increase the amount of reusable materials and to minimize the amount to be disposed of.

All redundant packing material has been omitted. We have done our utmost to make the packaging easily separable into mono materials.

Please find out about the local regulations on how to dispose of your old monitor and packing from your representative.

2. Setting up the monitor

2.1 Installation

1 Package contents

27E1N1800AE

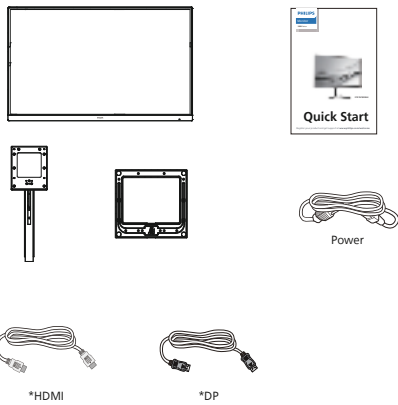

27E1N1900AE

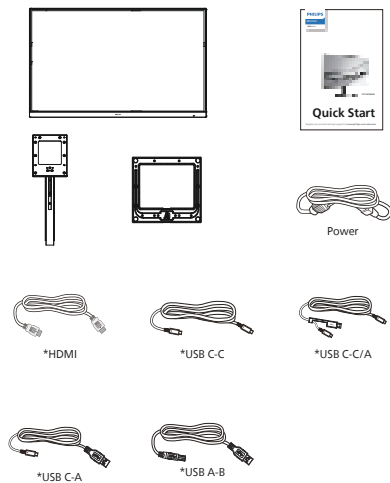

*Different according to region

2 Install the base

1. Place the monitor face down on a smooth surface. Pay attention not to scratch or damage the screen.

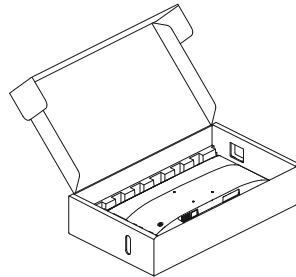

2. Hold the stand with both hands.
 - (1) Use a screwdriver to tighten the assembly screws, and secure the stand to the monitor tightly.
 - (2) Gently attach the base to the stand.
 - (3) Use your fingers to tighten the screws located at the bottom of the base, and secure the base to the stand tightly.

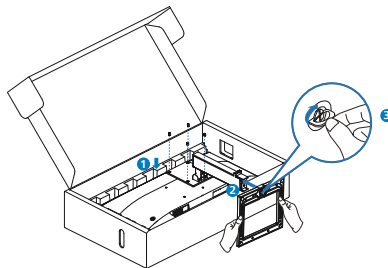

3 Connecting to your PC

27E1N1800AE

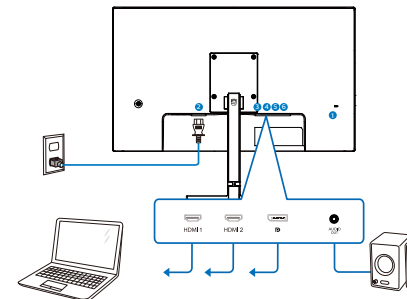

- 1 Kensington anti-theft lock
- 2 AC power input
- 3 HDMI 1 input
- 4 HDMI 2 input
- 5 DisplayPort input
- 6 Audio Out

Connect to PC

1. Connect the power cord to the back of the monitor firmly.
2. Turn off your computer and unplug its power cable.
3. Connect the monitor signal cable to the video connector on the back of your computer.
4. Plug the power cord of your computer and your monitor into a nearby outlet.
5. Turn on your computer and monitor. If the monitor displays an image, installation is complete.

4 USB hub

To comply with International energy standards, the USB hub/ports of this monitor are disabled during Standby and Off modes.

Connected USB devices will not work in this state.

5 USB charging

This monitor has USB ports capable of standard power output including some with USB Charging function (identifiable with power icon ). You can use these ports to charge your Smart phone or power your external HDD, for example. The monitor must be powered ON at all times to be able to use this function.

Warning





USB 2.4Ghz wireless devices, such as, wireless mouse, keyboard, and headphones, maybe have interference by USB3.2 or higher version, the high-speed signal devices, which may result in a decreased efficiency of the radio transmission. Should this happen, please try the following methods to help reduce the effects of interference.

- Try to keep USB2.0 receivers away from USB3.2 or higher version of connection port.
- Use a standard USB extension cable or USB hub to increase the space between your wireless receiver and the USB3.2 or higher version of connection port.

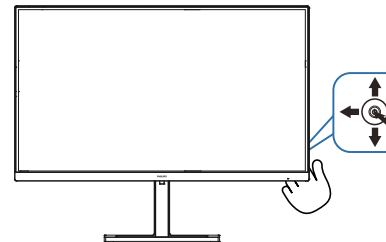
2.2 Operating the monitor

1 Description of the control buttons



1		Press to switch power on. Press more than 3 seconds to switch power off.
2		Access the OSD menu. Confirm the OSD adjustment.
3		Adjust the speaker volume. Adjust the OSD menu.
4		Change the signal input source. Adjust the OSD menu.
5		SmartImage. There are multiple selections: EasyView, Office, Photo, Movie, Game, Economy, LowBlue Mode, SmartUniformity, Off. When the monitor receives an HDR signal, SmartImage will show the HDR menu. There are multiple selections: HDR Vivid, HDR Movie, Personal, Off. Return to previous OSD menu.

Main menu	Sub menu	
LowBlue Mode	On	1, 2, 3, 4
	Off	
Input	1 HDMI 2.0	
	2 HDMI 2.0	
	DisplayPort(27EIN1800AE)	
	USB C(27EIN1900AE)	
	Auto	On, Off
Picture	SmartImage	EasyRead/Office/Photo/Movie/Game/Economy/LowBlue Mode/SmartUniformity/Off
	SmartImage HDR	HDR Vivid/HDR Movie/Personal/Off
	Adaptive Sync	On, Off
	Picture Format	Wide Screen, 4:3
	Brightness	0-100
	Contrast	0-100
	Sharpness	0-100
	SmartResponse	Off, Fast, Faster, Fastest
	SmartContrast	On, Off
	Gamma	1.8, 2.0, 2.2, 2.4, 2.6
	Pixel Orbiting	On, Off
	Over Scan	On, Off
	Audio	Volume
Mute		On, Off
Color	Color Temperature	Native, 5000K, 6500K, 7500K, 8200K, 9300K, 11500K
	sRGB	
	User Define	Red: 0-100 Green: 0-100 Blue: 0-100
Language	English, Deutsch, Español, Ελληνική, Français, Italiano, Magyar, Nederlands, Português, Português do Brasil, Polski, Русский, Svenska, Suomi, Türkçe, Čeština, Українська, 简体中文, 繁體中文, 日本語, 한국어	
OSD Setting	Horizontal	0-100
	Vertical	0-100
	Transparency	Off, 1, 2, 3, 4
	OSD Time Out	5s, 10s, 20s, 30s, 60s
USB Setting (27EIN1900AE)	USB-C Setting	High Data Speed, High Resolution
	USB Standby Mode	On, Off
Setup	Resolution Notification	On, Off
	Smart Power (27EIN1900AE)	On, Off
	Reset	Yes, No
	Information	

3 Resolution notification

This monitor is designed for optimal performance at its native resolution, 3840 x 2160. When the monitor is powered on at a different resolution, an alert is displayed on screen: Use 3840 x 2160 for best results.

Display of the native resolution alert can be switched off from Setup in the OSD (On Screen Display) menu.

4 Physical Function

Tilt

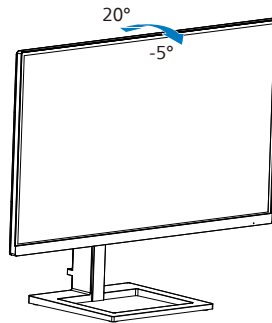

Height adjustment

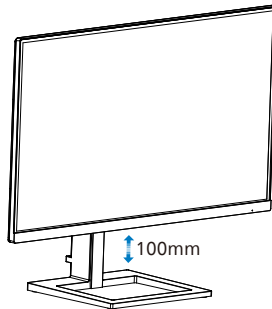

Warning

- To avoid potential screen damage, such as panel peeling, ensure that the monitor does not tilt downward by more than -5 degrees.
- Do not press the screen while adjusting the angle of the monitor. Grasp only the bezel.

2.3 Remove the Base Assembly for VESA Mounting

Before you start disassembling the monitor base, please follow the instructions below to avoid any possible damage or injury.

- Place the monitor face down on a smooth surface. Pay attention not to scratch or damage the screen.

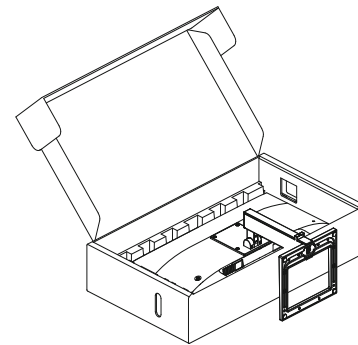

- Loosen the assembly screws, then detach the neck from the monitor.

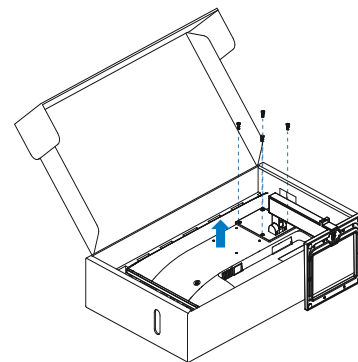

Note

This monitor accepts a 100mm x 100mm VESA-Compliant mounting interface. VESA Mounting Screw M4. Always contact manufacturer for wall-mount installation.

3. Image Optimization

3.1 SmartImage

1 What is it?

SmartImage provides presets that optimize display for different types of content, dynamically adjusting brightness, contrast, color and sharpness in real time. Whether you're working with text applications, displaying images or watching a video, Philips SmartImage delivers great optimized monitor performance.

2 Why do I need it?

You want a monitor that delivers optimized display all your favorite types of content, SmartImage software dynamically adjust brightness, contrast, color and sharpness in real time to enhance your monitor viewing experience.

3 How does it work?

SmartImage is an exclusive, leading edge Philips technology that analyzes the content displayed on your screen. Based on a scenario you select, SmartImage dynamically enhances the contrast, color saturation and sharpness of images to enhance the contents being displayed - all in real time with the press of a single button.

4 How to enable SmartImage?

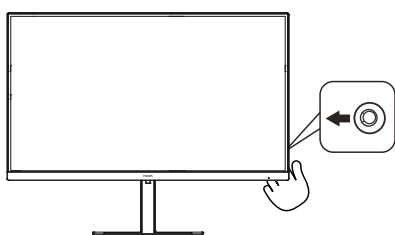

1. Toggle to the left to launch the SmartImage on screen display.
2. Toggle to the up or down to select between the smartImage modes.
3. The SmartImage on screen display will remain on screen for 5 seconds, or you can also toggle to the left to make confirmation.

There are multiple selections: EasyRead, Office, Photo, Movie, Game, Economy, LowBlue Mode, SmartUniformity, Off.

 SmartImage
EasyRead
Office
Photo
Movie
Game
Economy
LowBlue Mode
SmartUniformity
Off

- **EasyRead:** Helps improve reading of text based application like PDF ebooks. By using a special algorithm which increases the contrast and boundary sharpness of text content, the display is optimized for a stress-free reading by adjusting the brightness, contrast and color temperature of the monitor.
- **Office:** Enhances text and dampens brightness to increase readability and reduce eye strain. This mode significantly enhances readability and productivity when you're working with spreadsheets, PDF files,

scanned articles or other general office applications.

- **Photo:** This profile combines color saturation, dynamic contrast and sharpness enhancement to display photos and other images with outstanding clarity in vibrant colors - all without artifacts and faded colors.
- **Movie:** Ramped up luminance, deepened color saturation, dynamic contrast and razor sharpness display every details in darker areas of your videos without color wash in brighter areas maintaining a dynamic natural values for the ultimate video display.
- **Game:** Turn on over drive circuit for best response time, reduce jagged edges for fast moving objects on screen, enhance contrast ratio for bright and dark scheme, this profile delivers the best gaming experience for gamers.
- **Economy:** Under this profile, brightness, contrast are adjusted and backlighting finetuned for just right display of everyday office applications and lower power consumption.
- **LowBlue Mode:** LowBlue Mode is easy on-the-eyes productivity. Studies have shown that just as ultra-violet rays can cause eye damage, shortwave length blue light rays from LED displays can cause eye damage and affect vision over time. Developed for wellbeing, Philips LowBlue Mode setting uses a smart software technology to reduce harmful shortwave blue light.
- **SmartUniformity:** Fluctuations in brightness and color on different parts of a screen are a common phenomenon among LCD monitors. Typical uniformity is measured

3.2 SmartContrast

1 What is it?

Unique technology that dynamically analyzes displayed content and automatically optimizes a Monitor's contrast ratio for maximum visual clarity and viewing enjoyment, stepping up backlighting for clearer, crisper and brighter images or dimming backlighting for clear display of images on dark backgrounds.

2 Why do I need it?

You want the very best visual clarity and viewing comfort for every type of content. SmartContrast dynamically controls contrast and adjusts backlighting for clear, crisp, bright gaming and video images or displays clear, readable text for office work. By reducing your monitor's power consumption, you save on energy costs and extend the lifetime of your monitor.

3 How does it work?

When you activate SmartContrast, it will analyse the content you are displaying in real time to adjust colors and control backlight intensity. This function will dynamically enhance contrast for a great entertainment experience when viewing videos or playing games.

4. Power Delivery and Smart Power (27E1N1900AE)

You can power your compatible device with up to 65 Watts of power from the monitor.

1 What is it?

Smart Power is an exclusive Philips technology that provides flexible power delivery options for various devices.

This is useful for recharging high performance laptops with only one cable.

With Smart Power, the monitor makes it possible to deliver up to 65W of power through the USB-C port, compared to the standard 45W.

To prevent damaging the device, Smart Power enables protections to limit current draw.

2 How to enable Smart Power?

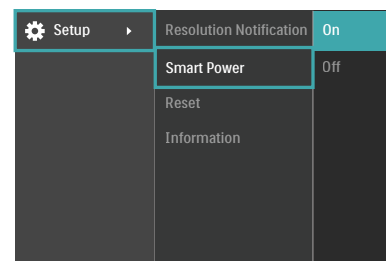

1. Toggle to the right to enter OSD Menu Screen.
2. Toggle to the up or down to select main menu [Setup], then toggle to the right to confirm.
3. Toggle to the up or down to turn on or off the [Smart Power].

5. Adaptive Sync



Adaptive Sync

PC gaming has long been an imperfect experience because GPUs and monitors update at different rates. Sometimes a GPU can render many new pictures during a single update of the monitor, and the monitor will show pieces of each picture as a single image. This is called "tearing." Gamers can fix tearing with a feature called "v-sync," but the image can become jerky as the GPU waits on the monitor to call for an update before delivering new pictures.

The responsiveness of mouse input and overall frames per second are reduced with v-sync, too. AMD Adaptive Sync technology eliminates all of these problems by letting the GPU update the monitor the moment a new picture is ready, leaving gamers with unbelievably smooth, responsive, tearing-free games.

Followed by the graphic card that are compatible.

- Operating system
 - Windows 11/10
- Graphic Card: R9 290/300 Series & R7 260 Series
 - AMD Radeon R9 300 Series
 - AMD Radeon R9 Fury X
 - AMD Radeon R9 360
 - AMD Radeon R7 360
 - AMD Radeon R9 295X2
 - AMD Radeon R9 290X
 - AMD Radeon R9 290
 - AMD Radeon R9 285

- AMD Radeon R7 260X
- AMD Radeon R7 260
- Processor A-Series Desktop and Mobility APUs
 - AMD A10-7890K
 - AMD A10-7870K
 - AMD A10-7850K
 - AMD A10-7800
 - AMD A10-7700K
 - AMD A8-7670K
 - AMD A8-7650K
 - AMD A8-7600
 - AMD A6-7400K

6. HDR

HDR Settings in Windows 11/10 system Steps

1. Right click on the desktop, enter Display settings.
2. Select the display/monitor.
3. Select an HDR-capable display under Rearrange your displays.
4. Select Windows HD Color settings.
5. Adjust Brightness for SDR content.

📌 **Note**
Windows 11/10 edition is required; always upgrade to the most updated version.

Below linkage is for the further more information from microsoft official website.

<https://support.microsoft.com/en-au/help/4040263/windows-10-how-to-enable-advanced-color-settings>



7. Technical Specifications

Picture/Display	
Monitor Panel Type	IPS Technology
Backlight	W-LED
Panel Size	27" W (68.5 cm)
Aspect Ratio	16:9
Pixel Pitch	0.1554 (H) mm x 0.1554 (V) mm
Contrast Ratio(typ.)	1000:1
Native Resolution	3840 x 2160 @ 60 Hz
Maximum Resolution	3840 x 2160 @ 60 Hz
Viewing Angle	178° (H) / 178° (V) @ C/R > 10 (typ.)
Monitor Colors	1.07B (8bits+Hi-FRC)
Flicker Free	Yes
Picture Enhancement	SmartImage
Vertical Refresh Rate	40 Hz - 60 Hz
Horizontal Frequency	30 KHz - 140 KHz
sRGB	YES
SmartUniformity	YES
Delta-E	YES
LowBlue Mode	YES
EasyRead	YES
HDR	YES
Adaptive Sync	YES
Connectivity	
Signal Input source	HDMI, DisplayPort
Connectors	27E1N1800AE: 2 x HDMI 2.0 (HDCP 1.4/ HDCP 2.2) 1 x DisplayPort 1.4 (HDCP 1.4/ HDCP 2.2) 1 x Audio out 27E1N1900AE: 2 x HDMI 2.0 (HDCP 1.4/ HDCP 2.2) 1 x USB-C (DP Alt mode) 1 x Audio out
Sync input	Separate Sync
USB(27E1N1900AE)	
USB Ports	USB-C x1 (upstream, DP Alt mode, HDCP 2.2/HDCP 1.4) USB-A x2 (downstream with x1 fast charge B.C 1.2)
Power Delivery	USB-C: USB PD version 3.0, typical 65W (5V/3A, 7V/3A, 9V/3A, 10V/3A, 12V/3A, 15V/3A, 20V/2.25A, 20V/3.25A) USB-A: x1 fast charge B.C 1.2, up to 7.5W (5V/1.5A)
Super Speed	USB-C/USB-A: USB 3.2 Gen1, 5 Gbps

Convenience	
Built-in speakers	2W x 2
OSD Languages	English, Dutch, F, Swedish, Chinese
Other Convenience	VESA m
Plug & Play Compatibility	DDC/CI,
Stand	
Tilt	-5 / +20
Height adjustment	100 mm
Power(27E1N1800AE)	
Consumption	AC at 1 60H
Normal Operation	27.
Sleep (Standby mode)	0.5
Off mode	0.3
Heat Dissipation*	AC at 1 60H
Normal Operation	93. (typ
Sleep (Standby mode)	1.7 (typ
Off mode	1.0. (typ
Power LED indicator	On
Power Supply	Buil
Power(27E1N1900AE)	
Consumption	AC at 1 60H
Normal Operation	27.
Sleep (Standby mode)	0.5
Off mode	0.3
Heat Dissipation*	AC at 1 60H
Normal Operation	92. (typ
Sleep (Standby mode)	1.7 (typ

Off mode	1.02 BTU/hr (typ.)	1.02 BTU/hr (typ.)	1.02 BTU/hr (typ.)
Power LED indicator	On mode: White, Standby/Sleep mode: White (blinking)		
Power Supply	Built-in, 100-240VAC, 50/60Hz		
Dimensions			
Product with stand (WxHxD)	613 x 492 x 220 mm		
Product without stand (WxHxD)	613 x 365 x 54 mm		
Product with packaging (WxHxD)	780 x 447 x 160 mm		
Weight			
Product with stand	27E1N1800AE: 5.69 kg 27E1N1900AE: 5.97 kg		
Product without stand	27E1N1800AE: 3.92 kg 27E1N1900AE: 4.20 kg		
Product with packaging	27E1N1800AE: 8.40 kg 27E1N1900AE: 8.68 kg		
Operating Condition			
Temperature range (operation)	0°C to 40°C		
Relative humidity (operation)	20% to 80%		
Atmospheric pressure (operation)	700 to 1060hPa		
Temperature range (Non-operation)	-20°C to 60°C		
Relative humidity (Non-operation)	10% to 90%		
Atmospheric pressure (Non-operation)	500 to 1060hPa		
Environmental and energy			
ROHS	YES		
Packaging	100% recyclable		
Specific Substances	100% PVC BFR free housing		
Cabinet			
Color	Black		
Finish	Texture		

Note

1. This data is subject to change without notice. Go to www.philips.com/support to download the latest version of leaflet.
2. SmartUniformity and Delta E information sheets are included in the box.

Display Input Format

27E1N1800AE

	422/420 (HDMI)
3840 x 2160 @60Hz, 10bits	N/A
3840 x 2160 @60Hz, 8bits	N/A
3840 x 2160 @30Hz, 10bits	OK
3840 x 2160 @30Hz, 8bits	OK
1920 x 1080 @ 60Hz, 10bits	OK
1920 x 1080 @ 60Hz, 8bits	OK

27E1N1900AE

	422/420 (HDMI2.0)
3840 x 2160 @60Hz, 10bits	N/A
3840 x 2160 @60Hz, 8bits	N/A
3840 x 2160 @30Hz, 10bits	OK
3840 x 2160 @30Hz, 8bits	OK
1920 x 1080 @60Hz, 10bits	OK
1920 x 1080 @60Hz, 8bits	OK

Note

In order for the monitor to function DisplayPort 1.4 or HDMI 2.0.

7.1 Resolution & Preset Modes

H. freq (kHz)	Resolution	V. freq (Hz)
31.47	720 x 400	70.09
31.47	640 x 480	59.94
35.00	640 x 480	66.67
37.86	640 x 480	72.81
37.50	640 x 480	75.00
37.88	800 x 600	60.32
46.88	800 x 600	75.00
48.36	1024 x 768	60.00
60.02	1024 x 768	75.03
44.77	1280x 720	59.86
63.89	1280 x 1024	60.02
79.98	1280 x 1024	75.03
55.94	1440 x 900	59.89
65.29	1680 x 1050	59.95
67.50	1920 x 1080	60.00
88.79	2560 x 1440	59.95
67.50	3840 x 2160	30.00
133.32	3840 x 2160	60.00

Note

Please notice that your display works best at native resolution of 3840 x 2160.

For best output performance, please always ensure that your graphic card is capable of achieving the maximum resolution and refresh rate of this Philips display.

8. Power Management

If you have VESA DPM compliance card or software installed in your PC, your monitor can automatically reduce its power consumption when not in use. When an input from a keyboard, mouse or other input device is detected, the monitor will 'wake up' automatically. The following table shows the power consumption and signaling of this automatic power saving feature:

27E1N1800AE

Power Management Definition				
VESA Mode	Video	H-sync	V-sync	Power Use
Active	ON	Yes	Yes	27.24 (typ) 52.51 (max)
Sleep (Standby mode)	OFF	No	No	0.5 (typ)
Off mode	OFF	-	-	0.3 (typ)

27E1N1900AE

Power Management Definition				
VESA Mode	Video	H-sync	V-sync	Power Use
Active	ON	Yes	Yes	26.97 (typ) 137.9 (max)
Sleep (Standby mode)	OFF	No	No	0.5 (typ)
Off mode	OFF	-	-	0.3 (typ)

9. Customer care and warranty

9.1 Philips' Flat Panel Monitors Pixel Defect Policy

Philips strives to deliver the highest quality products. We use some of the industry's most advanced manufacturing processes and practice stringent quality control. However, pixel or sub pixel defects on the TFT Monitor panels used in flat panel monitors are sometimes unavoidable. No manufacturer can guarantee that all panels will be free from pixel defects, but Philips guarantees that any monitor with an unacceptable number of defects will be repaired or replaced under warranty. This notice explains the different types of pixel defects and defines acceptable defect levels for each type. In order to qualify for repair or replacement under warranty, the number of pixel defects on a TFT Monitor panel must exceed these acceptable levels. For example, no more than 0.0004% of the sub pixels on a monitor may be defective. Furthermore, Philips sets even higher quality standards for certain types or combinations of pixel defects that are more noticeable than others. This policy is valid worldwide.

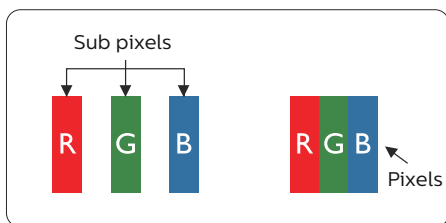

Pixels and Sub pixels

A pixel, or picture element, is composed of three sub pixels in the primary colors of red, green and blue. Many pixels

together form an image. When all sub pixels of a pixel are lit, the three colored sub pixels together appear as a single white pixel. When all are dark, the three colored sub pixels together appear as a single black pixel. Other combinations of lit and dark sub pixels appear as single pixels of other colors.

Types of Pixel Defects

Pixel and sub pixel defects appear on the screen in different ways. There are two categories of pixel defects and several types of sub pixel defects within each category.

Bright Dot Defects

Bright dot defects appear as pixels or sub pixels that are always lit or 'on'. That is, a bright dot is a sub-pixel that stands out on the screen when the monitor displays a dark pattern. There are the types of bright dot defects.

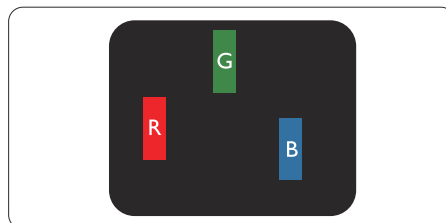

One lit red, green or blue sub pixel.

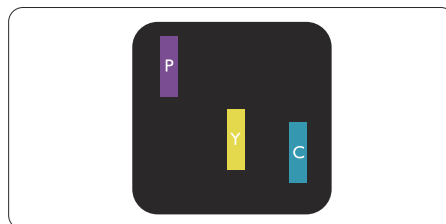

Two adjacent lit sub pixels:

- Red + Blue = Purple
- Red + Green = Yellow
- Green + Blue = Cyan (Light Blue)

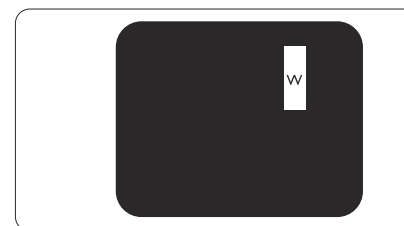

Three adjacent lit sub pixels (one white pixel).

Note
A red or blue bright dot must be more than 50 percent brighter than neighboring dots while a green bright dot is 30 percent brighter than neighboring dots.

Black Dot Defects

Black dot defects appear as pixels or sub pixels that are always dark or 'off'. That is, a dark dot is a sub-pixel that stands out on the screen when the monitor displays a light pattern. These are the types of black dot defects.

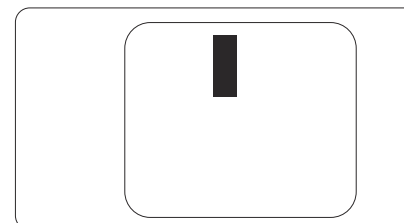

BRIGHT DOT DEFECTS	ACCEPTABLE LEVEL
1 lit subpixel	2
2 adjacent lit subpixels	1
3 adjacent lit subpixels (one white pixel)	0
Distance between two bright dot defects*	>15mm
Total bright dot defects of all types	2
BLACK DOT DEFECTS	ACCEPTABLE LEVEL
1 dark subpixel	3 or fewer
2 adjacent dark subpixels	2 or fewer
3 adjacent dark subpixels	0
Distance between two black dot defects*	>15mm
Total black dot defects of all types	3 or fewer
TOTAL DOT DEFECTS	ACCEPTABLE LEVEL
Total bright or black dot defects of all types	5 or fewer

 **Note**
1 or 2 adjacent sub pixel defects = 1 dot defect

9.2 Customer Care & Warranty

For warranty coverage information in your region, please visit www.philips.com or contact your Philips Customer Care Center.

For Warranty Period please refer to the User Manual.

For extended warranty, if you would like to purchase an Out of Warranty service package is available.

If you wish to make use of this service, the warranty period will be extended for a certain number of calendar days of your original purchase date. This service includes pickup, repair and return of the product for all costs accrued.

If the Certified Service Partner cannot be reached, please contact your Philips Customer Care Center for an extended warranty package, we will extend the extended warranty period you purchased.

Please contact our Philips Customer Care Center (Philips Consumer care number) for more details.

Philips Customer Care Center number:

• Local Standard Warranty Period	• Extended Warranty Period
• Depend on different Regions	• + 1 Year
	• + 2 Year
	• + 3 Year

**Proof of original purchase and extended warranty required.

 **Note**
Please refer to important information available on the Philips website www.philips.com

10. Troubleshooting & FAQs

10.1 Troubleshooting

This page deals with problems that can be corrected by a user. If the problem still persists after you have tried these solutions, contact Philips customer service representative.

1 Common Problems

No Picture (Power LED not lit)

- Make sure the power cord is plugged into the power outlet and into the back of the monitor.
- First, ensure that the power button on the rear of the monitor is in the OFF position, then press it to the ON position.

No Picture (Power LED is White)

- Make sure the computer is turned on.
- Make sure the signal cable is properly connected to your computer.
- Make sure the monitor cable has no bent pins on the connect side. If yes, repair or replace the cable.
- The Energy Saving feature may be activated

Screen says

Check cable connection

- Make sure the monitor cable is properly connected to your computer. (Also refer to the Quick Start Guide).
- Check to see if the monitor cable has bent pins.

- Make sure the computer is turned on.

AUTO button doesn't function

- The auto function is applicable only in VGA-Analog mode. If the result is not satisfactory, you can do manual adjustments via the OSD menu.



Note

The Auto Function is not applicable in DVI-Digital mode as it is not necessary.

Visible signs of smoke or sparks

- Do not perform any troubleshooting steps
- Disconnect the monitor from mains power source immediately for safety
- Contact with Philips customer service representative immediately.

2 Imaging Problems

Image is not centered

- Adjust the image position using the "Auto" function in OSD Main Controls.
- Adjust the image position using the Phase/Clock of Setup in OSD Main Controls. It is valid only in VGA mode.

Image vibrates on the screen

- Check that the signal cable is properly securely connected to the graphics board or PC.

Vertical flicker appears



- Adjust the image using the "Auto" function in OSD Main Controls.
- Eliminate the vertical bars using the Phase/Clock of Setup in OSD Main Controls. It is valid only in VGA mode.

Horizontal flicker appears



- Adjust the image using the "Auto" function in OSD Main Controls.
- Eliminate the vertical bars using the Phase/Clock of Setup in OSD Main Controls. It is valid only in VGA mode.

Image appears blurred, indistinct or dark

- Adjust the contrast and brightness on On-Screen Display.

An "after-image", "burn-in" or "ghost image" remains after the power has been turned off.

- Uninterrupted display of still or static images over an extended period may cause "burn-in", also known as "after-imaging" or "ghost imaging", on your screen. "Burn-in", "after-imaging", or "ghost imaging" is a well-known phenomenon in LCD panel technology. In most cases, the "burn-in" or "after-imaging" or "ghost imaging" will disappear gradually over a period of time after the power has been switched off.
- Always activate a moving screen saver program when you leave your monitor unattended.
- Always activate a periodic screen refresh application if your LCD monitor will display unchanging static content.
- Failure to activate a screen saver or a periodic screen refresh application may result in severe "burn-in" or "after-imaging" or "ghost imaging" symptoms that will not disappear and cannot be repaired. The damage mentioned above is not covered under your warranty.

10.2 General FAQs

Q1: When I install my monitor what should I do if the screen shows 'Cannot display this video mode'?

Ans.: Recommended resolution for this monitor: 3840 x 2160.

- Unplug all cables, then connect your PC to the monitor that you used previously.
- In the Windows Start Menu, select Settings/Control Panel. In the Control Panel Window, select the Display icon. Inside the Display Control Panel, select the 'Settings' tab. Under the setting tab, in box labelled 'desktop area', move the sidebar to 3840 x 2160 pixels.
- Open 'Advanced Properties' and set the Refresh Rate to 60 Hz, then click OK.
- Restart your computer and repeat step 2 and 3 to verify that your PC is set at 3840 x 2160.
- Shut down your computer, disconnect your old monitor and reconnect your Philips LCD monitor.
- Turn on your monitor and then turn on your PC.

Q2: What is the recommended refresh rate for LCD monitor?

Ans.: Recommended refresh rate in LCD monitors is 60 Hz, In case of any disturbance on screen, you can set it up to 75 Hz to see if that removes the disturbance.

Q3: What are the .inf and .icm files? How do I install the drivers (.inf and .icm)?

Ans.: These are the driver files for your monitor. Your computer may ask you for monitor drivers (.inf and .icm files) when you first install your monitor. Follow the

instructions in your user manual, monitor drivers (.inf and .icm files) will be installed automatically.

Q4: How do I adjust the resolution?

Ans.: Your video card/graphic driver and monitor together determine the available resolutions. You can select the desired resolution under Windows® Control Panel with the "Display properties".

Q5: What if I get lost when I am making monitor adjustments via OSD?

Ans.: Simply press the **➡** button, then select [Reset] to recall all the original factory settings.

Q6: Is the LCD screen resistant to scratches?

Ans.: In general it is recommended that the panel surface is not subjected to excessive shocks and is protected from sharp or blunt objects. When handling the monitor, make sure that there is no pressure or force applied to the panel surface side. This may affect your warranty conditions.

Q7: How should I clean the LCD surface?

Ans.: For normal cleaning, use a clean, soft cloth. For extensive cleaning, please use isopropyl alcohol. Do not use other solvents such as ethyl alcohol, ethanol, acetone, hexane, etc.

Q8: Can I change the color setting of my monitor?

Ans.: Yes, you can change your color setting through OSD control as the following procedures.

- Press **➡** button to show the OSD (On Screen Display) menu

- Press **↓** button to select the option [Color] then press **➡** button to enter color setting, there are three settings as below.

1. Color Temperature: The settings are Native, 5000K, 6500K, 7500K, 8200K, 9300K and 11500K. Native settings in the 5000K range the panel appears "warm, with a red-white color tone", while 11500K temperature yields "bluishwhite toning".
2. sRGB: This is a standard setting for ensuring correct exchange of colors between different devices (e.g. digital cameras, monitors, printers, scanners, etc).
3. User Define: The user can choose his/her preference color setting by adjusting red, green, blue color.

Note

A measurement of the color of light radiated by an object while it is being heated. This measurement is expressed in terms of absolute scale, (degrees Kelvin). Lower Kelvin temperatures such as 2004K are red; higher temperatures such as 9300K are blue. Neutral temperature is white, at 6504K.

Q9: Can I connect my LCD monitor to any PC, workstation or Mac?

Ans.: Yes. All Philips LCD monitors are fully compatible with standard PCs, Macs and workstations. You may need a cable adapter to connect the monitor to your Mac system. Please contact your Philips sales representative for more information.

Q13: How to unlock/lock my hot key?

Ans.: Please press ↓ for 10 seconds to unlock/lock the hot key, by doing so, your display pops out "Attention" to show the unlock/lock status as shown below illustrators.

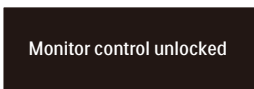

Monitor control unlocked

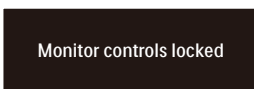

Monitor controls locked

Q14: Where can I find Important Information manual mentioned in EDFU?

Ans.: Important Information manual can be download on the Philips website support page.

2024 © TOP Victory Investments Ltd. All rights reserved.

This product has been manufactured by and is sold by TOP Victory Investments Ltd. is the warrantor in relation to this product. Philips and Koninklijke Philips N.V. are used under license.

Specifications are subject to change without notice.

Version: 27E1N1800EE1T