



User Guide

AC750 Dual-Band Wi-Fi Router
Archer C24

Contents

About This Guide	1
Chapter 1. Get to Know About Your Router	3
1. 1. Product Overview.....	4
1. 2. Appearance	4
1. 2. 1.Top Panel	4
1. 2. 2.The Back Panel.....	5
Chapter 2. Connect to the Internet	6
2. 1. Position Your Router	7
2. 2. Connect to the Internet	8
2. 2. 1.Wireless Router Mode.....	8
2. 2. 2.Access Point Mode.....	10
2. 2. 3.Range Extender Mode.....	12
Chapter 3. Log In to the Router	14
Chapter 4. Configure the Router in Wireless Router Mode	16
4. 1. Operation Mode	17
4. 2. Network	17
4. 2. 1.Status.....	17
4. 2. 2.Internet	19
4. 2. 3.MAC Clone.....	25
4. 2. 4.LAN.....	26
4. 2. 5.IPTV	26
4. 2. 6.DHCP Server.....	27
4. 2. 7.Dynamic DNS	29
4. 2. 8.Static Routing	30
4. 3. Wireless	31
4. 3. 1.Wireless Settings	31
4. 3. 2.Guest Network	33
4. 3. 3.Wireless Schedule	34
4. 3. 4.WPS	35
4. 3. 5.Additional Wireless Settings.....	37
4. 4. NAT Forwarding.....	38
4. 4. 1.Port Forwarding.....	38

4. 4. 2.	Port Triggering	40
4. 4. 3.	DMZ	41
4. 4. 4.	UPnP	42
4. 5.	Parental Controls	43
4. 6.	QoS	45
4. 7.	Security	46
4. 7. 1.	Firewall.....	47
4. 7. 2.	Access Control.....	47
4. 7. 3.	IP & MAC Binding.....	49
4. 8.	ALG (Application Layer Gateway).....	51
4. 9.	IPv6	51
4. 9. 1.	IPv6 Status.....	51
4. 10.	System	55
4. 10. 1.	Firmware Upgrade	55
4. 10. 2.	Backup & Restore	55
4. 10. 3.	Change Password.....	56
4. 10. 4.	Local Management	57
4. 10. 5.	Remote Management	58
4. 10. 6.	System Log	59
4. 10. 7.	Diagnostic	60
4. 10. 8.	Time Settings.....	61
4. 10. 9.	Reboot	63
4. 10. 10.	LED Control	63

Chapter 5. Configure the Router in Access Point Mode 65

5. 1.	Operation Mode	66
5. 2.	Firmware Upgrade	66
5. 3.	Backup & Restore.....	67
5. 4.	Administration.....	68
5. 4. 1.	Change Password	68
5. 4. 2.	Local Management.....	68
5. 5.	System Log.....	69
5. 6.	Diagnostic.....	70
5. 7.	Time Settings.....	71
5. 8.	Reboot	73
5. 9.	LED Control	73

Chapter 6. Configure the Router in Range Extender Mode 75

6. 1.	Operation Mode	76
6. 2.	Firmware Upgrade	76

6.3.	Backup & Restore.....	77
6.4.	Administration.....	78
	6.4.1.Change Password.....	78
	6.4.2.Local Management.....	78
6.5.	System Log.....	79
6.6.	Time Settings.....	80
6.7.	Reboot.....	81
6.8.	LED Control.....	82
	FAQ.....	84

About This Guide

This guide is a complement of Quick Installation Guide. The Quick Installation Guide instructs you on quick internet setup, and this guide provides details of each function and shows you the way to configure these functions appropriate to your needs.

When using this guide, please note that features available of the router may vary by model and software version. Router's availability may also vary by region or ISP. All images, steps, and descriptions in this guide are only examples and may not reflect your actual experience.

Conventions

In this guide the following conventions are used:

Convention	Description
<u>Underlined</u>	Underlined words or phrases are hyperlinks. You can click to redirect to a website or a specific section.
Teal	Contents to be emphasized and texts on the web page are in teal, including the menus, items, buttons, etc.
>	The menu structures to show the path to load the corresponding page. For example, Advanced > Wireless > MAC Filtering means the MAC Filtering function page is under the Wireless menu that is located in the Advanced tab.
Note:	Ignoring this type of note might result in a malfunction or damage to the device.
Tips:	Indicates important information that helps you make better use of your device.
Symbols on the web page	<ul style="list-style-type: none">✎ Click to edit the corresponding entry.🗑️ Click to delete the corresponding entry.🔑 Click to enable or disable the corresponding entry.🔍 Click to view more information about items on the page.

*Maximum wireless signal rates are the physical rates derived from IEEE Standard 802.11 specifications. Actual wireless data throughput and wireless coverage are not guaranteed and will vary as a result of network conditions, client limitations, and environmental factors, including building materials, obstacles, volume and density of traffic, and client location.

More Info

- The latest software, management app and utility can be found at [Download Center](https://www.tp-link.com/support) at <https://www.tp-link.com/support>.
- The Quick Installation Guide can be found where you find this guide or inside the package of the router.
- Specifications can be found on the product page at <https://www.tp-link.com>.
- A TP-Link Community is provided for you to discuss our products at <https://community.tp-link.com>.
- Our Technical Support contact information can be found at the [Contact Technical Support](https://www.tp-link.com/support) page at <https://www.tp-link.com/support>.

Chapter 1

Get to Know About Your Router

This chapter introduces what the router can do and shows its appearance.

It chapter contains the following sections:

- [Product Overview](#)
- [Appearance](#)

1.1. Product Overview

The TP-Link router is designed to fully meet the need of Small Office/Home Office (SOHO) networks and users demanding higher networking performance. The powerful antennas ensure continuous Wi-Fi signal to all your devices while boosting widespread coverage throughout your home, and the built-in Ethernet ports supply high-speed connection to your wired devices.

Moreover, it is simple and convenient to set up and use the TP-Link router due to its intuitive web interface and the powerful Tether app.



1.2. Appearance



1.2.1. Top Panel



The router's LEDs (view from left to right) are located on the front. You can check the router's working status by following the LED Explanation table.

LED Explanation:

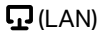
LED	Status	Indication
 (Power)	On	Power is on.
	Blinking	Blinking slowly: The system is starting up or firmware upgrade is in progress. Blinking quickly: WPS connection is in progress.
	Off	Power is off.
 (2.4GHz Wireless)	On	The 2.4GHz wireless band is enabled.
	Off	The 2.4GHz wireless band is disabled.

LED	Status	Indication
 (5GHz Wireless)	On	The 5GHz wireless band is enabled.
	Off	The 5GHz wireless band is disabled.
 (LAN)	On	At least one powered-on device is connected to the router's LAN port.
	Off	No powered-on device is connected to the router's LAN port.
 (Internet)	Green On	Router Mode: Internet is available. Access Point Mode: The WAN port is connected. Range Extender Mode: The router is connected to the host network.
	Orange On	The WAN port is connected, but internet is not available.
	Off	Router Mode: The WAN port is not connected. Access Point Mode: The WAN port is not connected. Range Extender Mode: The router is not connected to the host network.

1.2.2. The Back Panel



The following parts (view from left to right) are located on the back panel.

Button and Port Explanation

Item	Description
Power Port	For connecting the router to a power socket via the provided power adapter.
WAN Port	For connecting to a DSL/Cable modem, or an Ethernet jack.
LAN Ports (1/2/3/4)	For connecting your PC or other wired devices to the router.
WPS/RESET Button	Press the button for 1 second, and immediately press the WPS button on your client to start the WPS process.
	Press and hold the button until all LEDs turn off to reset the router to its factory default settings.
Antennas	Used for wireless operation and data transmit. Upright them for the best Wi-Fi performance.

Chapter 2

Connect to the Internet

This chapter contains the following sections:

- [Position Your Router](#)
- [Connect to the Internet](#)

2.1. Position Your Router

With the router, you can access your network from anywhere within the wireless network coverage. However, the wireless signal strength and coverage vary depending on the actual environment of your router. Many obstacles may limit the range of the wireless signal, for example, concrete structures or thick walls.

For your security and best Wi-Fi performance, please:

- Do NOT locate the router in a place where it will be exposed to moisture or excessive heat.
- Keep away from the strong electromagnetic radiation and the device of electromagnetic sensitive.
- Place the router in a location where it can be connected to the various devices as well as to a power source.
- Make sure the cables and power cord are safely placed out of the way to avoid a tripping hazard.

Generally, the router is placed on a horizontal surface, such as on a shelf or desktop. The device also can be mounted on the wall as shown in the following figure.

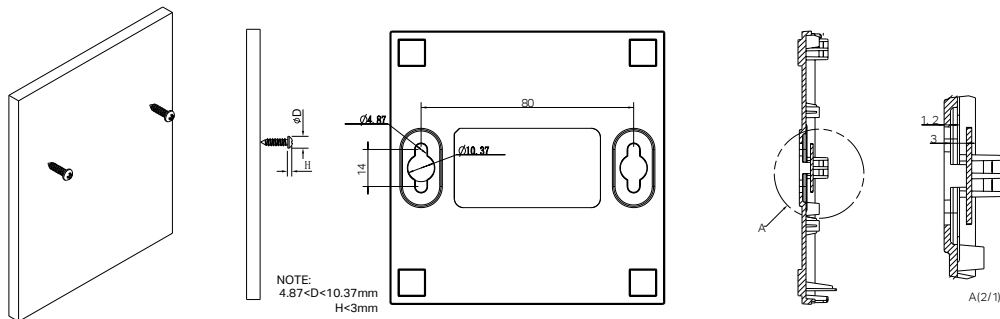

Note:

The diameter of the screw, $4.87\text{mm} < D < 10.37\text{mm}$, and the distance of two screws is 80mm. The screw that project from the wall need around 4mm based, and the length of the screw need to be at least 20mm to withstand the weight of the product.

2.2. Connect to the Internet

The Router provides three working modes: Wireless Router, Range Extender and Access Point. You can choose the mode to better suit your network needs and follow the guide to complete the configuration.

2.2.1. Wireless Router Mode

1. Follow the steps below to connect your router.

If your internet connection is through an Ethernet cable from the wall instead of through a DSL / Cable / Satellite modem, connect the Ethernet cable directly to the router's WAN port, and then follow Step 4 and 5 to complete the hardware connection.

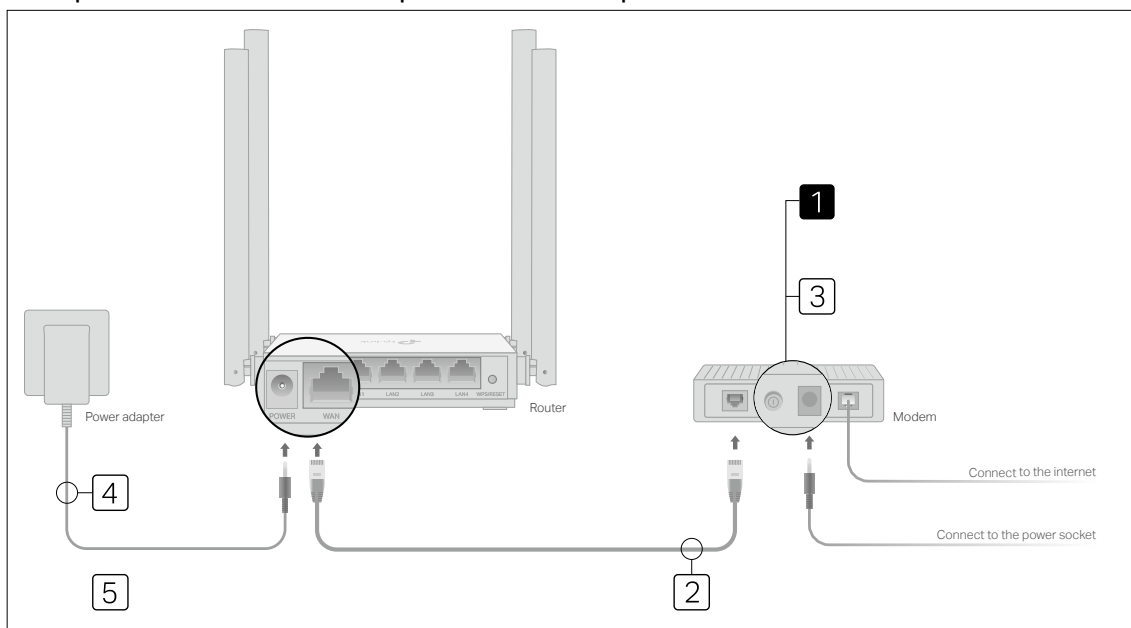

- 1) Power off the modem, and remove the backup battery if it has one.
 - 2) Connect the powered-off modem to the router's **WAN** port with an Ethernet cable.
 - 3) Turn on the modem, and then wait about **2 minutes** for it to restart.
 - 4) Connect the power adapter to the router.
 - 5) Verify that the internet LED turns solid before continuing with the configuration.
2. Connect your computer to the router.

- **Method 1: Wired**

Turn off the Wi-Fi on your computer and connect your computer to the router's LAN port.

- **Method 2: Wireless**

- 1) Connect your device to the router's Wi-Fi using the SSID (network name) and Wireless Password printed on the label at the bottom of the router.
- 2) Click the network icon of your computer or go to Wi-Fi Settings of your smart device, and then select the SSID to join the network.

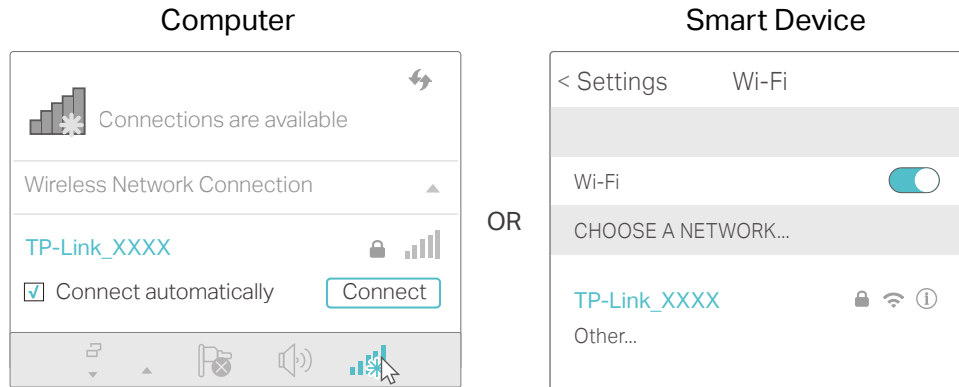

- **Method 3: Use the WPS button**

Wireless devices that support WPS, including Android phones, tablets, most USB network cards, can be connected to your router through this method.

Note:

- WPS is not supported by iOS devices.
- The WPS function cannot be configured if the wireless function of the router is disabled. Also, the WPS function will be disabled if your wireless encryption is WEP. Please make sure the wireless function is enabled and is configured with the appropriate encryption before configuring the WPS.

- 1) Tap the WPS icon on the device's screen. Here we take an Android phone as an example.
- 2) Immediately press the WPS button on your router.

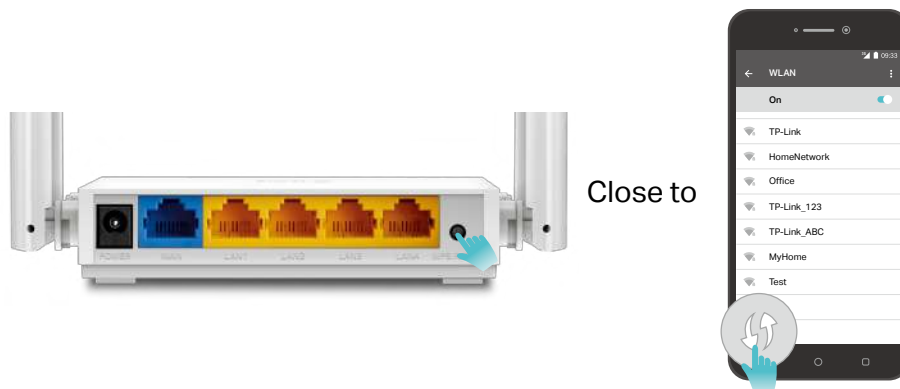

3. Enter <http://tplinkwifi.net> in the address bar of a web browser. Create a password to log in.

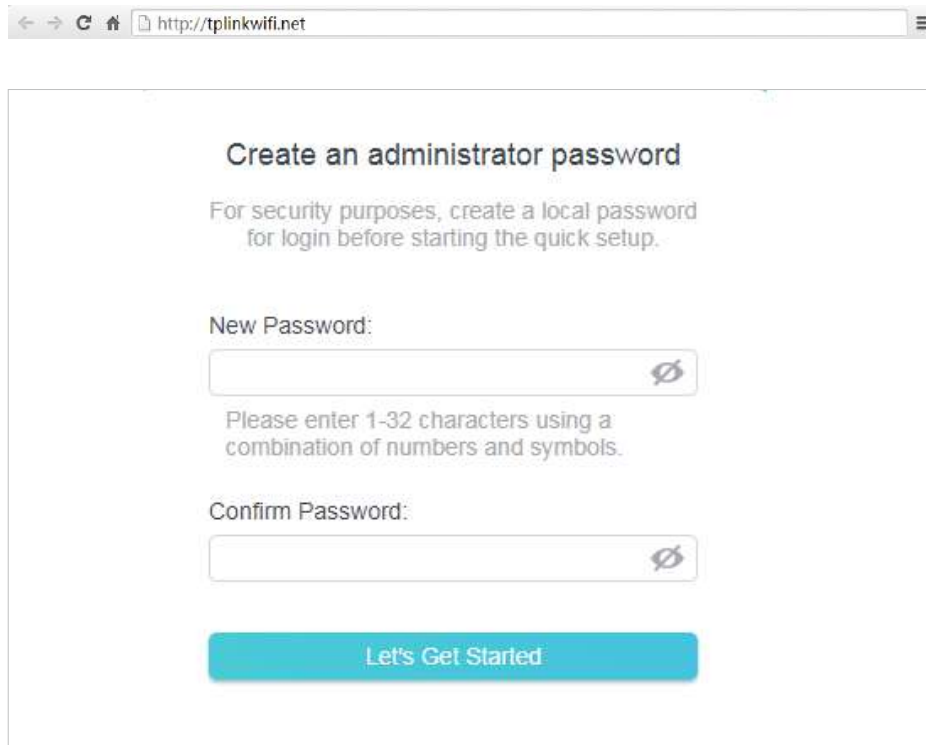

The screenshot shows a web browser window with the address bar containing <http://tplinkwifi.net>. The main content area displays the following text and form elements:

Create an administrator password

For security purposes, create a local password for login before starting the quick setup.

New Password:

Please enter 1-32 characters using a combination of numbers and symbols.

Confirm Password:

Let's Get Started

Note:

If the above screen does not pop-up, it means that your IE Web-browser has been set to a proxy. Go to menu **Tools** > **Internet Options** > **Connections** > **LAN Settings**, in the screen that appears, untick the **Using Proxy** checkbox, and click **OK**.

4. Follow the **Quick Setup** to set up the internet connection.
5. **Enjoy!** For wireless devices, you may have to reconnect to the wireless network if you have customized the SSID (wireless name) and password during the configuration.

2.2.2. Access Point Mode

This mode transforms your existing wired network to a wireless network.

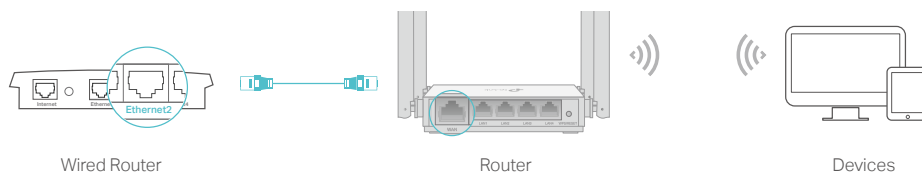

1. Connect the power adapter to the router.
2. Connect the router to your wired host router's Ethernet port via an Ethernet cable as shown above.
3. Connect a computer to the router via an Ethernet cable or wirelessly by using the SSID (network name) and password printed on the bottom label of the router.
4. Enter <http://tplinkwifi.net> in the address bar of a web browser. Create a password to log in.

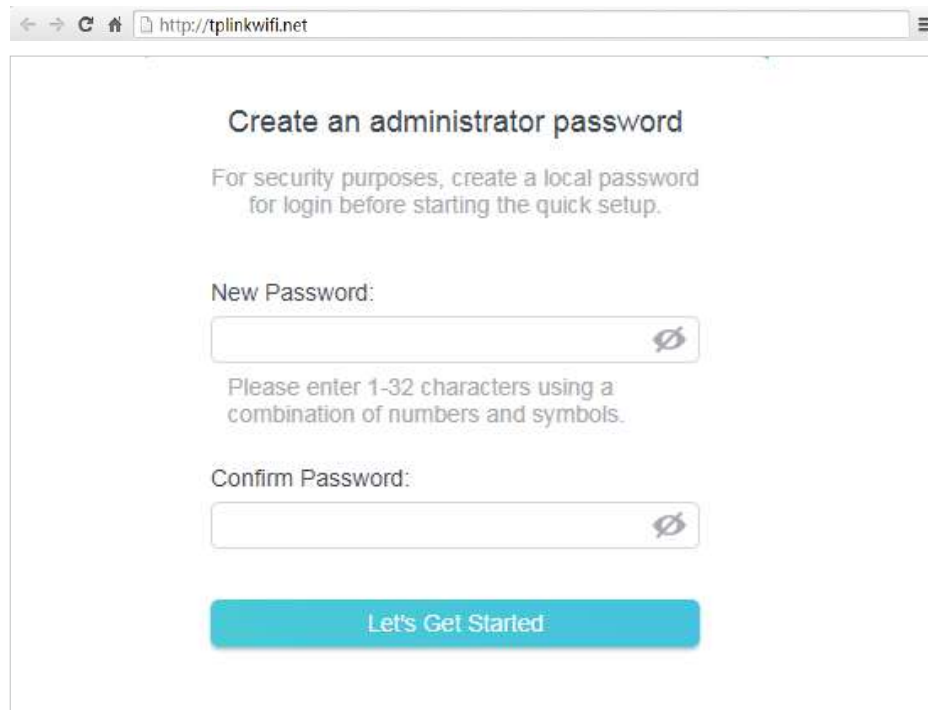

The screenshot shows a web browser window with the address bar containing <http://tplinkwifi.net>. The main content area displays the following text and form elements:

Create an administrator password

For security purposes, create a local password for login before starting the quick setup.

New Password:

Please enter 1-32 characters using a combination of numbers and symbols.

Confirm Password:

Note:

If the above screen does not pop-up, it means that your IE Web-browser has been set to a proxy. Go to menu **Tools** > **Internet Options** > **Connections** > **LAN Settings**, in the screen that appears, untick the **Using Proxy** checkbox, and click **OK**.

5. Click **Change Mode** in the top right corner and select **Access Point Mode**. Wait for the router to reboot.

6. Follow the [Quick Setup](#) to set up the internet connection.
7. [Enjoy!](#) Connect to the wireless network by using the SSID (network name) and password of the router.

2.2.3. Range Extender Mode

This mode boosts your home wireless coverage.

1. Connect the power adapter to the router.
2. Connect a computer to the router via an Ethernet cable or wirelessly by using the SSID (wireless name) and password printed on the bottom label of the router.
3. Enter <http://tplinkwifi.net> in the address bar of a web browser. Create a password to log in.

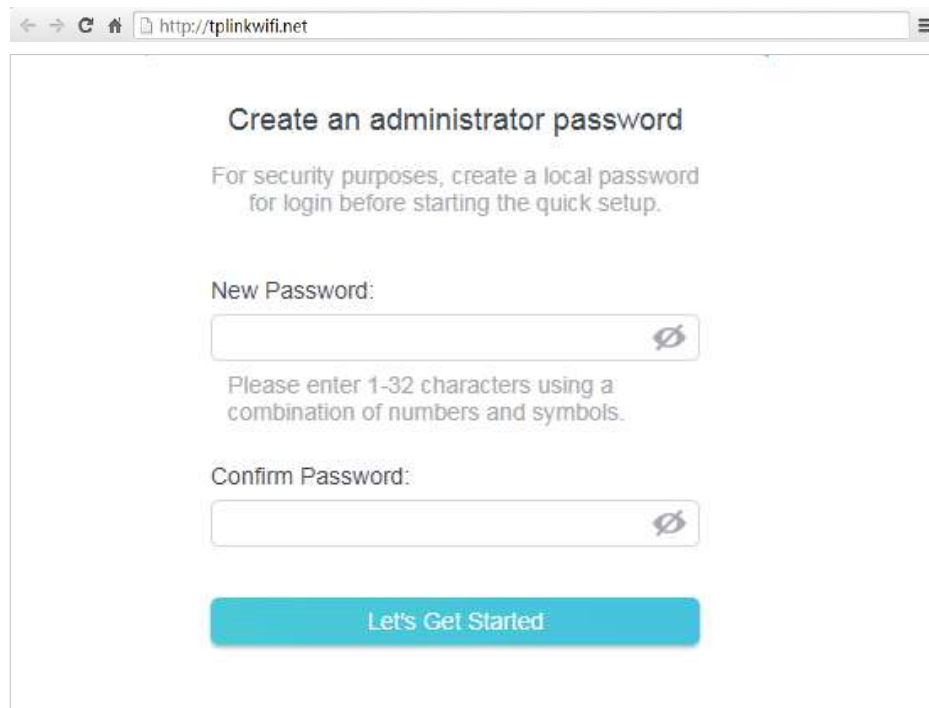

4. Click [Change Mode](#) in the top right corner and select [Range Extender Mode](#). Wait for the router to reboot.
5. Follow the [Quick Setup](#) to set up the internet connection.
6. [Relocate:](#) Place the router between your host router and the Wi-Fi dead zone. The location you choose must be within the range of your existing host network.

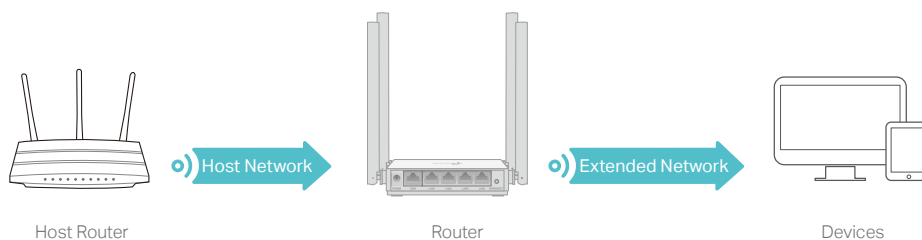

7. **Enjoy!** You can customize the SSID and password of the extended network.

Chapter 3

Log In to the Router

This chapter introduces how to log in to the web management page of the router.

With the web-based utility, it is easy to configure and manage the router. The web-based utility can be used on any Windows, Macintosh or UNIX OS with a Web browser, such as Microsoft the Internet Explorer, Mozilla Firefox or Apple Safari.

Follow the steps below to log in to your router.

1. Set up the TCP/IP Protocol in [Obtain an IP address automatically](#) mode on your computer.
2. Visit <http://tplinkwifi.net>, and log in with the password you set for the router.

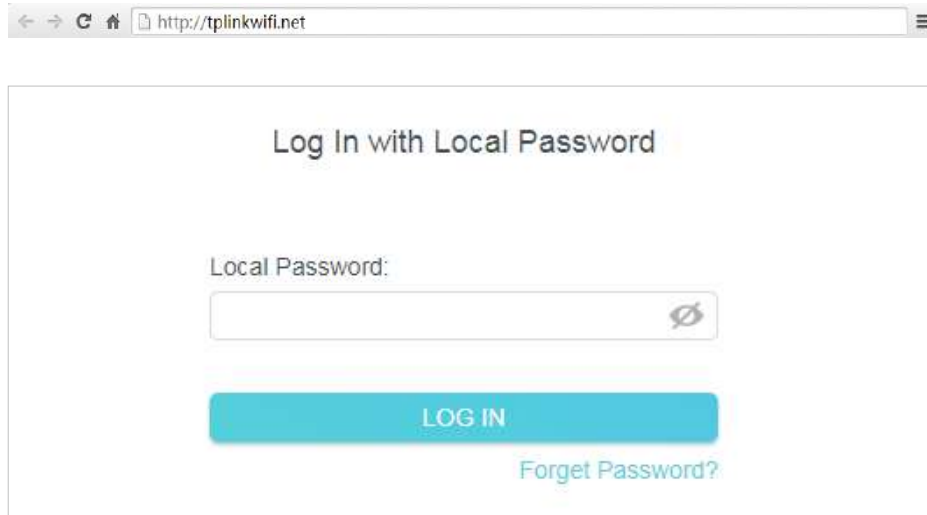

Note:

If the login window does not appear, please refer to the [FAQ](#) section.

Chapter 4

Configure the Router in Wireless Router Mode

This chapter presents how to configure the various features of the router working as a wireless router.

It contains the following sections:

- [Operation Mode](#)
- [Network](#)
- [Wireless](#)
- [NAT Forwarding](#)
- [Parental Controls](#)
- [QoS](#)
- [Security](#)
- [IPv6](#)
- [System](#)

4.1. Operation Mode

1. Visit <http://tplinkwifi.net>, and log in with the password you set for the router.
2. Go to [Advanced](#) > [Operation Mode](#).
3. Select the working mode as needed and click [SAVE](#).

Operation Mode

Select an operation mode according to your needs.

Router Mode(Current)

In this mode, the router can provide internet access for multiple wired and wireless devices. This mode is required most commonly.



Access Point Mode

In this mode, the router changes an existing wired network into a wireless one.

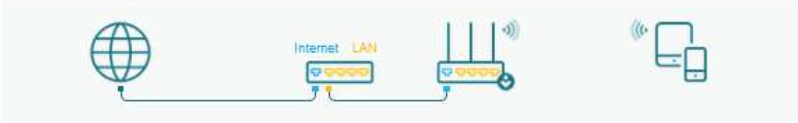

Range Extender Mode

In this mode, the router boosts the existing wireless coverage in your home.



4.2. Network

4.2.1. Status

1. Visit <http://tplinkwifi.net>, and log in with password you set for the router.
2. Go to [Advanced](#) > [Network](#) > [Status](#). You can view the current status information of the router.

Status

Internet status overview is displayed on this page.

Internet

Status: Connected

Internet Connection Type: Dynamic IP

IP Address: 10.0.2.224

Subnet Mask: 255.255.252.0

Default Gateway: 10.0.0.1

Primary DNS: 10.0.0.1

Secondary DNS: 0.0.0.0

LAN

MAC Address: 00-19-66-CA-8B-07

IP Address: 192.168.0.1

Subnet Mask: 255.255.255.0

DHCP Server

DHCP Server: Enabled

IP Address Pool: 192.168.0.100-192.168.0.199

Dynamic DNS

Service Provider: NO-IP

Host Name:

Status: Disconnected

- **Internet** - This field displays the current settings of the internet, and you can configure them on the [Advanced > Network > Internet](#) page.
 - **Status** - Indicates whether the router has been connected to the internet.
 - **Internet Connection Type** - Indicates the way in which your router is connected to the internet.
 - **IP Address** - The WAN IP address of the router.
 - **Subnet Mask** - The subnet mask associated with the WAN IP address.
 - **Default Gateway** - The Gateway currently used is shown here. When you use Dynamic IP as the internet connection type, click [Renew](#) or [Release](#) here to obtain new IP parameters dynamically from the ISP or release them.
 - **Primary & Secondary DNS** - The IP addresses of DNS (Domain Name System) server.

- **LAN** - This field displays the current settings of the LAN, and you can configure them on the [Advanced > Network > LAN](#) page.
 - **MAC Address** - The physical address of the router.
 - **IP Address** - The LAN IP address of the router.
 - **Subnet Mask** - The subnet mask associated with the LAN IP address.
- **DHCP Server** - This field displays the current settings of DHCP (Dynamic Host Configuration Protocol) Server, and you can configure them on the [Network > DHCP Server](#) page.
 - **DHCP Server** - Indicates whether the DHCP server is enabled or disabled. It is enabled by default and the router acts as a DHCP server.
 - **IP Address Pool** - The IP address range for the DHCP server to assign IP addresses.
- **Dynamic DNS** - This field displays the current settings of the Dynamic DNS (Domain Name System), and you can configure them on the [Advanced > Network > Dynamic DNS](#) page.
 - **Service Provider** - The Dynamic DNS service provider you have signed up for.
 - **Host Name** - The Domain Name you have entered in the [Dynamic DNS](#) page.
 - **Status** - The status of the Dynamic DNS service connection.

4.2.2. Internet

1. Visit <http://tplinkwifi.net>, and log in with the password you set for the router.
2. Go to [Advanced > Network > Internet](#).
3. Set up the internet connection and click [SAVE](#).

Dynamic IP

If your ISP provides the DHCP service, please select [Dynamic IP](#), and the router will automatically get IP parameters from your ISP.

Click [Renew](#) to renew the IP parameters from your ISP.

Click [Release](#) to release the IP parameters.

Internet

Set up an internet connection with the service information provided by your ISP (internet service provider).

Internet Connection Type:

IP Address: 10.0.2.224

Subnet Mask: 255.255.252.0

Default Gateway: 10.0.0.1

Primary DNS: 10.0.0.1

Secondary DNS: 0.0.0.0

DNS Address:

Primary DNS: 10.0.0.1

Secondary DNS: 0.0.0.0

MTU Size: bytes

The default is 1500, do not change unless necessary.

Host Name:

Get IP with Unicast DHCP

- **MTU Size** - The normal MTU (Maximum Transmission Unit) value for most Ethernet networks is 1500 Bytes. It is not recommended that you change the default MTU size unless required by your ISP.
- **Host Name** - This option specifies the name of the router.
- **Get IP with Unicast DHCP** - A few ISPs' DHCP servers do support the broadcast applications. If you cannot get the IP address normally, you can choose this option (it is rarely required).

Static IP

If your ISP provides a static or fixed IP address, subnet mask, default gateway and DNS setting, please select **Static IP**.

Internet

Set up an internet connection with the service information provided by your ISP (internet service provider).

Internet Connection Type:

IP Address:

Subnet Mask:

Default Gateway:

Primary DNS:

Secondary DNS: (Optional)

MTU Size: bytes

(Do not change unless necessary.)

- **IP Address** - Enter the IP address in dotted-decimal notation provided by your ISP.
- **Subnet Mask** - Enter the subnet mask in dotted-decimal notation provided by your ISP. Normally 255.255.255.0 is used as the subnet mask.
- **Default Gateway** - Enter the gateway IP address in dotted-decimal notation provided by your ISP.
- **Primary/Secondary DNS** - (Optional) Enter one or two DNS addresses in dotted-decimal notation provided by your ISP.
- **MTU Size** - The normal MTU (Maximum Transmission Unit) value for most Ethernet networks is 1500 Bytes. It is not recommended that you change the default MTU size unless required by your ISP.

PPPoE

If your ISP provides PPPoE connection, select **PPPoE**.

Internet

Set up an internet connection with the service information provided by your ISP (internet service provider).

Internet Connection Type:

Username:

Password:

IP Address: 0.0.0.0

Primary DNS: 0.0.0.0

Secondary DNS: 0.0.0.0

▼ Advanced Settings

Secondary Connection:

MTU Size: bytes
The default is 1480, do not change unless necessary.

Service Name:
(Leave blank unless ISP requires.)

Access Concentrator Name:
(Leave blank unless ISP requires.)

Detect Online Interval: seconds

IP Address:

DNS Address:

Primary DNS: 0.0.0.0

Secondary DNS: 0.0.0.0

Connection Mode:

- **User Name/Password** - Enter the user name and password provided by your ISP. These fields are case-sensitive.
- **Secondary Connection** - It's available only for PPPoE connection. If your ISP provides an extra connection type, select **Dynamic IP** or **Static IP** to activate the secondary connection.
- **MTU Size** - The default MTU size is 1480 bytes. It is not recommended that you change the default MTU size unless required by your ISP.
- **Service Name** - The service name should not be configured unless you are sure it is necessary for your ISP. In most cases, leaving these fields blank will work.
- **Access Concentrator Name** - The access concentrator name should not be configured unless you are sure it is necessary for your ISP. In most cases, leaving these fields blank will work.
- **Detect Online Interval** - The router will detect Access Concentrator online at every interval. The default value is 10. You can input the value between 0 and 120. The value 0 means no detect.
- **IP Address** - The default setting is to get an IP address dynamically from your ISP. If your ISP does not automatically assign IP addresses to the router, please select **Use the Following IP Address** and enter the IP address provided by your ISP in dotted-decimal notation.
- **DNS Address** - The default setting is to get an IP address dynamically from your ISP. If your ISP does not automatically assign DNS addresses to the router, please select **Use the Following DNS Addresses** and enter the IP address in dotted-decimal notation of your ISP's primary DNS server. If a secondary DNS server address is available, enter it as well.
- **Connection Mode** - Select an appropriate connection mode that determines how to connect to the internet.
 - **Auto** - In this mode, the internet connection reconnects automatically any it gets disconnected.
 - **On Demand** - In this mode, the internet connection will be terminated automatically after a specified inactivity period (Max Idle Time) and be re-established when you attempt to access the internet again.
 - **Time-based** - In this mode, the internet connection is only established in a specific timeframe. If this option is selected, enter the start time and end time. Both are in HH:MM format.
 - **Manual** - In this mode, the internet connection is controlled manually by clicking the **Connect/Disconnect** button. This mode also supports the **Max Idle Time** function as **On Demand** mode. Enter a maximum time (in minutes), the internet connection can be inactive before it is terminated into the Max Idle Time. The

default value is 15 minutes. If you want the internet connection remains active all the time, enter 0 (zero).

Note:

Sometimes the connection cannot be terminated although you have specified the [Max Idle Time](#) because some applications are visiting the internet continually in the background.

L2TP

If your ISP provides L2TP connection, please select [L2TP](#).

Internet
Set up an internet connection with the service information provided by your ISP (internet service provider).

Internet Connection Type: L2TP

Username: user@isp.com

Password: ...

IP Address: 0.0.0.0

Primary DNS: 0.0.0.0

Secondary DNS: 0.0.0.0

Dynamic IP
 Static IP

VPN Server IP/Domain Name:

IP Address: 0.0.0.0

Subnet Mask: 0.0.0.0

Default Gateway: 0.0.0.0

Primary DNS: 0.0.0.0

Secondary DNS: 0.0.0.0

MTU Size: 1460
The default is 1460, do not change unless necessary.

Connection Mode: Auto

CONNECT

DISCONNECT

- **Username/Password** - Enter the username and password provided by your ISP. These fields are case-sensitive.
- **VPN Server IP/ Domain Name** - Enter the VPN server's IP address or domain name provided by your ISP.
- **MTU Size** - The default MTU size is "1460" bytes, which is usually fine. It is not recommended that you change the default MTU Size unless required by your ISP.
- **Connection Mode**
 - **Auto** - In this mode, the internet connection reconnects automatically any it gets disconnected.

- **On Demand** - In this mode, the internet connection will be terminated automatically after a specified inactivity period (Max Idle Time) and be re-established when you attempt to access the internet again.
- **Manual** - In this mode, the internet connection is controlled manually by clicking the **Connect/Disconnect** button. This mode also supports the **Max Idle Time** function as **On Demand** mode. Enter a maximum time (in minutes), the internet connection can be inactive before it is terminated into the Max Idle Time. The default value is 15 minutes. If you want the internet connection remains active all the time, enter 0 (zero).

Note:

Sometimes the connection cannot be terminated although you have specified the **Max Idle Time** because some applications are visiting the internet continually in the background.

PPTP

If your ISP provides PPTP connection, please select **PPTP**.

Internet

Set up an internet connection with the service information provided by your ISP (internet service provider).

Internet Connection Type: PPTP

Username:

Password:

IP Address: 0.0.0.0

Primary DNS: 0.0.0.0

Secondary DNS: 0.0.0.0

Dynamic IP

Static IP

VPN Server IP/Domain Name:

IP Address: 0.0.0.0

Subnet Mask: 0.0.0.0

Default Gateway: 0.0.0.0

Primary DNS: 0.0.0.0

Secondary DNS: 0.0.0.0

MTU Size:

The default is 1420, do not change unless necessary.

Connection Mode: Auto

CONNECT

DISCONNECT

- **Username/Password** - Enter the username and password provided by your ISP. These fields are case-sensitive.

- **VPN Server IP/ Domain Name** - Enter the VPN server's IP address or domain name provided by your ISP.
- **MTU Size** - The default MTU size is "1420" bytes, which is usually fine. It is not recommended that you change the default MTU Size unless required by your ISP.
- **Connection Mode**
 - **Auto** - In this mode, the internet connection reconnects automatically any it gets disconnected.
 - **On Demand** - In this mode, the internet connection will be terminated automatically after a specified inactivity period (Max Idle Time) and be re-established when you attempt to access the internet again.
 - **Manual** - In this mode, the internet connection is controlled manually by clicking the **Connect/Disconnect** button. This mode also supports the **Max Idle Time** function as **On Demand** mode. Enter a maximum time (in minutes), the internet connection can be inactive before it is terminated into the Max Idle Time. The default value is 15 minutes. If you want the internet connection remains active all the time, enter 0 (zero).

Note:

Sometimes the connection cannot be terminated although you have specified the **Max Idle Time** because some applications are visiting the internet continually in the background.

4.2.3. MAC Clone

1. Visit <http://tplinkwifi.net>, and log in with the password you set for the router.
2. Go to **Advanced > Network > Internet** and locate the **MAC Clone** section.
3. Configure the WAN MAC address and click **SAVE**.

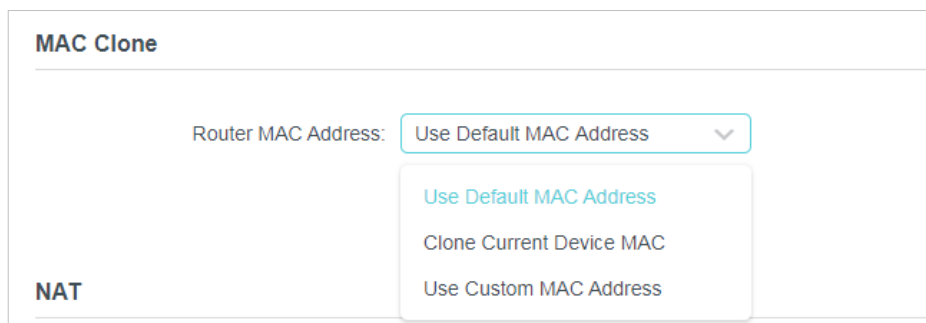

MAC Clone

Router MAC Address:

- Use Default MAC Address
- Clone Current Device MAC
- Use Custom MAC Address

NAT

- **Use Default MAC Address** - Do not change the default MAC address of your router in case the ISP does not bind the assigned IP address to the MAC address.
- **Use Current MAC Address** - Select to copy the current MAC address of the computer that is connected to the router, in case the ISP binds the assigned IP address to the MAC address.

- **Use Custom MAC Address** - Select if your ISP requires you to register the MAC address and enter the correct MAC address in this field, in case the ISP binds the assigned IP address to the specific MAC address.

Note:

- You can only use the MAC Address Clone function for PCs on the LAN.
- If you have changed the WAN MAC address when the WAN connection is PPPoE, it will not take effect until the connection is re-established.

4.2.4. LAN

1. Visit <http://tplinkwifi.net>, and log in with the password you set for the router.
2. Go to **Advanced > Network > LAN**.
3. Configure the IP parameters of the LAN and click **SAVE**.

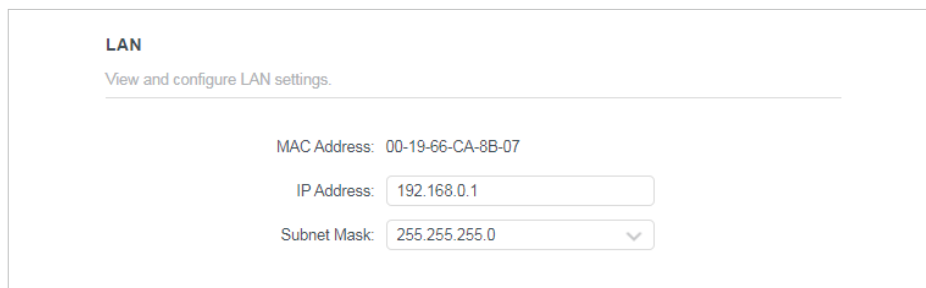

LAN
View and configure LAN settings.

MAC Address: 00-19-66-CA-8B-07

IP Address:

Subnet Mask: ▼

- **MAC Address** - The physical address of the LAN ports. The value can not be changed.
- **IP Address** - Enter the IP address in dotted-decimal notation of your router (the default one is 192.168.0.1).
- **Subnet Mask** - An address code that determines the size of the network. Normally 255.255.255.0 is used as the subnet mask.

Note:

- If you have changed the IP address, you must use the new IP address to log in.
- If the new IP address you set is not in the same subnet as the old one, the IP address pool in the DHCP Server will be configured automatically, but the Virtual Server and DMZ Host will not take effect until they are re-configured.

4.2.5. IPTV

1. Visit <http://tplinkwifi.net>, and log in with the password you set for the router.
2. Go to **Advanced > Network > IPTV/VLAN**.
3. Configure the WAN MAC address and click **Save**.

IPTV/VLAN
Configure IPTV/VLAN settings if you want to enjoy IPTV or VoIP service, or if your ISP requires VLAN tags.

IPTV/VLAN: Enable

Mode: Bridge

LAN1: Internet

LAN2: Internet

LAN3: IPTV

LAN4: IPTV

- **IPTV/VLAN** - Select to enable the IPTV feature.
- **Mode** - Select the appropriate mode according to your ISP.
- **LAN 1/2/3/4** - Assign your LAN port to whether function as the internet supplier or as the IPTV supplier.

4.2.6. DHCP Server

By default, the DHCP (Dynamic Host Configuration Protocol) Server is enabled and the router acts as a DHCP server; it dynamically assigns TCP/IP parameters to client devices from the IP Address Pool. You can change the settings of DHCP Server if necessary, and you can reserve LAN IP addresses for specified client devices.

- **To specify the IP address that the router assigns:**
 1. Visit <http://tplinkwifi.net>, and log in with the password you set for the router.
 2. Go to **Advanced > Network > DHCP Server** and locate the **DHCP Server** section.

DHCP Server
Dynamically assign IP addresses to the devices connected to the router.

DHCP Server: Enable

IP Address Pool: 192.168.0.100 - 192.168.0.199

Address Lease Time: 120 minutes

Default Gateway: 0.0.0.0 (Optional)

Primary DNS: 0.0.0.0 (Optional)

Secondary DNS: 0.0.0.0 (Optional)

1. Tick the **Enable** checkbox.
2. Enter the starting and ending IP addresses in the **IP Address Pool**.

3. Enter other parameters if the ISP offers. The **Default Gateway** is automatically filled in and is the same as the LAN IP address of the router.

4. Click **SAVE**.

Note:

To use the DHCP server function of the router, you must configure all computers on the LAN as **Obtain an IP Address automatically**.

- **To reserve an IP address for a specified client device:**

1. Visit <http://tplinkwifi.net>, and log in with the password you set for the router.
2. Go to **Advanced > Network > DHCP Server** and locate the **Address Reservation** section.
3. Click **Add** in the **Address Reservation** section.

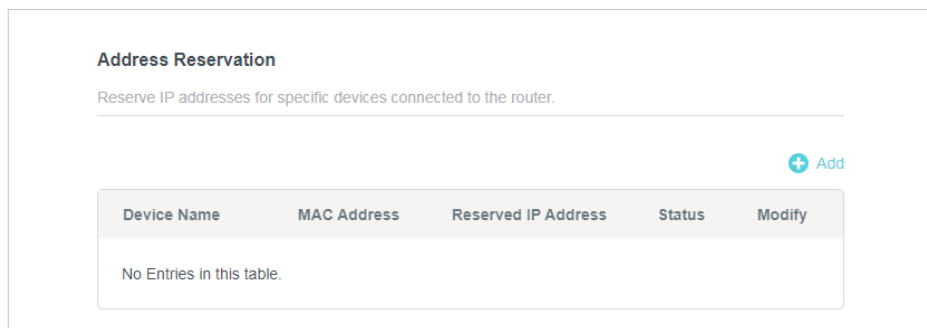

4. Click **VIEW CONNECTED DEVICES** and select the you device you want to reserve an IP for. Then the **MAC and IP Address** will be automatically filled in. You can also enter the **MAC and IP address** of the client device.

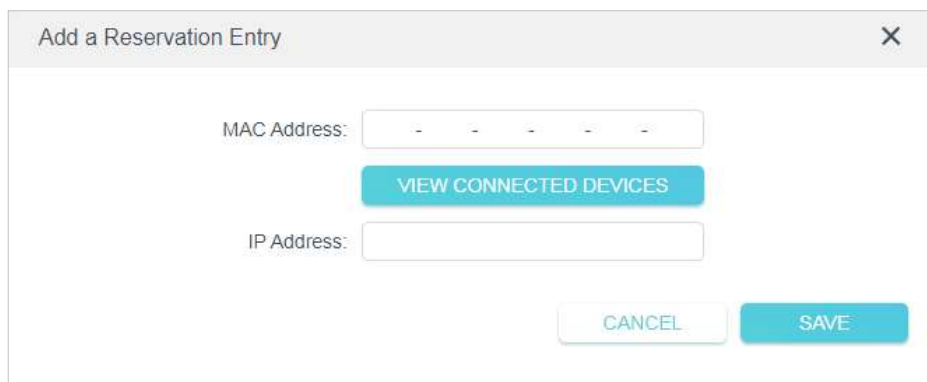

- **To check the DHCP client list:**

1. Visit <http://tplinkwifi.net>, and log in with the password you set for the router.
2. Go to **Advanced > Network > DHCP Server** and locate the **DHCP Client List** section. You can see the device information of the list.
3. Click **Refresh** to see the current attached devices.



Device Name	MAC Address	Assigned IP Address	Lease Time
Wireless	38-37-9E-49-57-FF	192.168.0.101	01:59:01

4.2.7. Dynamic DNS

The router offers the DDNS (Dynamic Domain Name System) feature, which allows the hosting of a website, FTP server, or e-mail server with a fixed domain name (named by yourself) and a dynamic IP address. Thus your friends can connect to your server by entering your domain name no matter what your IP address is. Before using this feature, you need to sign up for DDNS service providers such as www.comexe.cn, www.dyndns.org, or www.noip.com. The Dynamic DNS client service provider will give you a password or key.

1. Visit <http://tplinkwifi.net>, and log in with the username and password you set for the router.
2. Go to [Advanced > Network > Dynamic DNS](#).
3. Select the DDNS [Service Provider](#): NO-IP or DynDNS. If you don't have a DDNS account, you have to register first by clicking [Register Now](#).

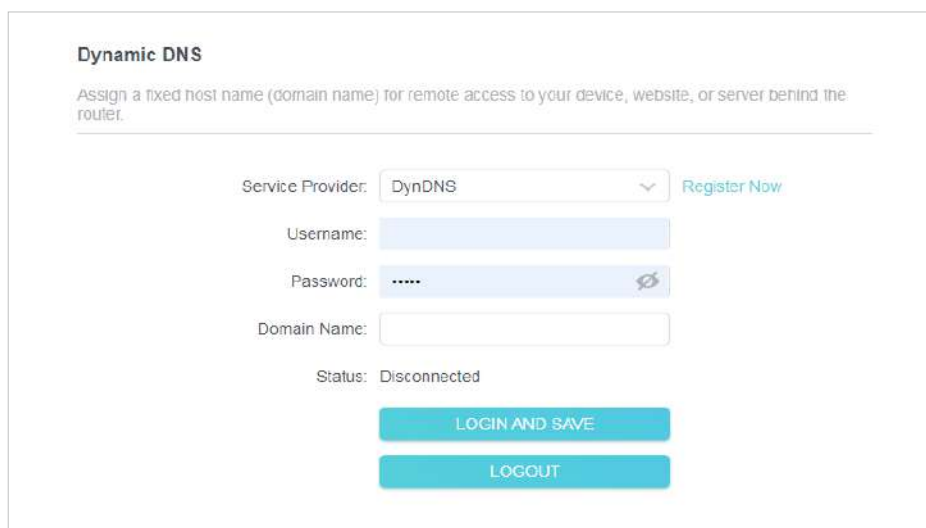

Dynamic DNS

Assign a fixed host name (domain name) for remote access to your device, website, or server behind the router.

Service Provider: [Register Now](#)

Username:

Password:

Domain Name:

Status: Disconnected

4. Enter the [Username](#) for your DDNS account.
5. Enter the [Password](#) for your DDNS account.
6. Enter the [Domain Name](#) you received from dynamic DNS service provider here.

7. If your service provider is NO-IP, select **WAN IP binding** to ensure that the domain name is bound to the WAN IP of this router.
8. Click **LOGIN AND SAVE**.

4.2.8. Static Routing

Static Routing is a form of routing that is configured manually by a network administrator or a user by adding entries into a routing table. The manually-configured routing information guides the router in forwarding data packets to the specific destination.

I want to:

Visit multiple networks and servers at the same time.

For example, in a small office, my PC can surf the internet through Router A, but I also want to visit my company's network. Now I have a switch and Router B. I connect the devices as shown in the following figure so that the physical connection between my PC and my company's server is established. To surf the internet and visit my company's network at the same time, I need to configure the static routing.

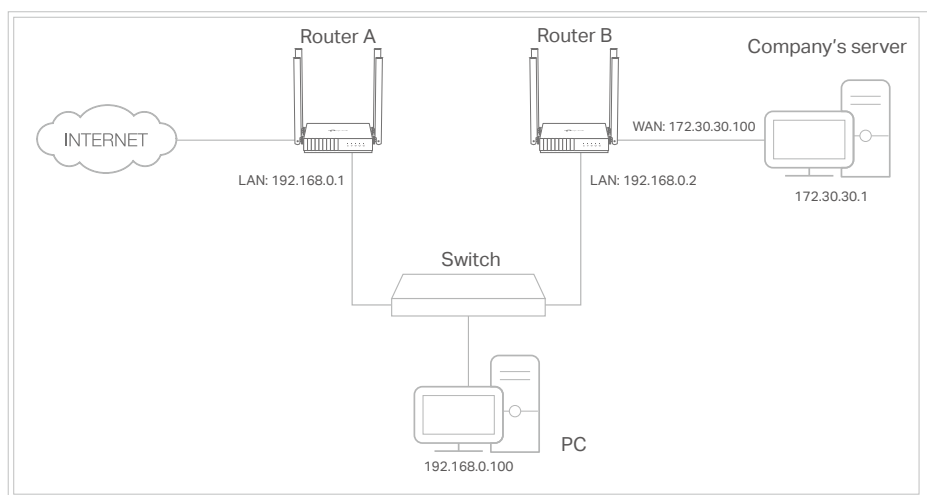

How can I do that?

1. Change the routers' LAN IP addresses to two different IP addresses on the same subnet. Disable Router B's DHCP function.
2. Visit <http://tplinkwifi.net>, and log in with the password you set for Router A.
3. Go to **Advanced > Network > Routing** and locate the **Static Routing** section.
4. Click **Add** and finish the settings according to the following explanations:

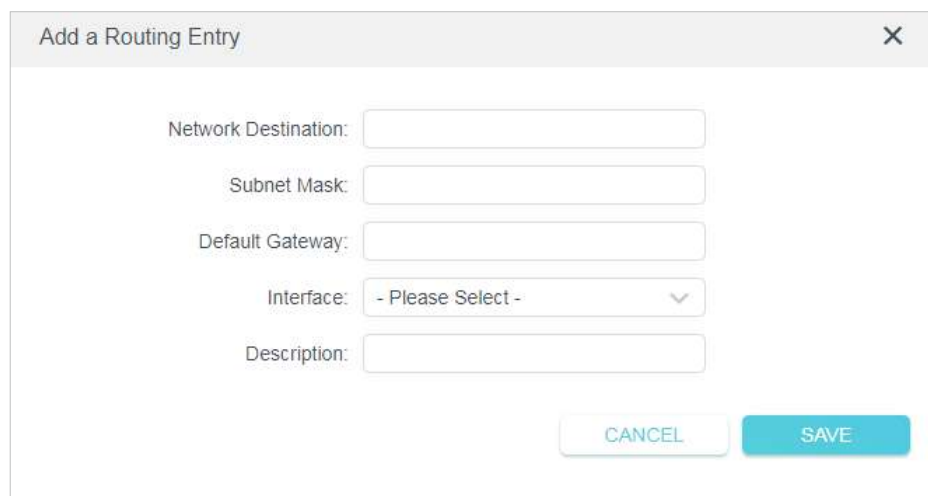

The screenshot shows a dialog box titled "Add a Routing Entry" with a close button (X) in the top right corner. The dialog contains the following fields:

- Network Destination:
- Subnet Mask:
- Default Gateway:
- Interface:
- Description:

At the bottom right of the dialog, there are two buttons: "CANCEL" and "SAVE".

- **Network Destination** - The destination IP address that you want to assign to a static route. This IP address cannot be on the same subnet with the WAN IP or LAN IP of Router A. In the example, the IP address of the company network is the destination IP address, so here enter 172.30.30.1.
 - **Subnet Mask** - The Subnet Mask determines which portion of an IP address is the network portion, and which portion is the host portion.
 - **Default Gateway** - The IP address of the gateway device to which the data packets will be sent. This IP address must be on the same subnet with the router's IP which sends out data. In the example, the data packets will be sent to the LAN port of Router B and then to the Server, so the default gateway should be 192.168.0.2.
 - **Interface**: Determined by the port (WAN/LAN) that sends out data packets. In the example, the data are sent to the gateway through the LAN port of Router A, so LAN should be selected.
 - **Description**: Enter a description for this static routing entry.
5. Click **SAVE**.
 6. Check the **Routing Table** below. If you can find the entry you've set, the static routing is set successfully.

4.3. Wireless

4.3.1. Wireless Settings

1. Visit <http://tplinkwifi.net>, and log in with the password you set for the router.
2. Go to **Advanced > Wireless > Wireless Settings**.
3. Configure the wireless settings for the wireless network and click **SAVE**.

Wireless Settings

Personalize wireless settings as you need.

2.4GHz: Enable [Sharing Network](#)

Network Name (SSID): Hide SSID

Security:

Version:

Encryption:

Password:

Transmit Power:

Channel Width:

Channel:

Mode:

- **2.4GHz** - Select this checkbox to enable the 2.4GHz wireless network.
- **Network Name (SSID)** - Enter a value of up to 32 characters. The same Name (SSID) must be assigned to all wireless devices in your network.
- **Hide SSID** - Select this checkbox if you want to hide the 2.4GHz network name (SSID) from the Wi-Fi network list. In this case, you need to manually join the network.
- **Security** - Select an option from the **Security** drop-down list.
 - **None** - No security. It is highly recommend you enable the wireless security to protect your wireless network from unauthorized access.
 - **WPA-PSK/WPA2-Personal** - It's the WPA/WPA2 authentication type based on pre-shared passphrase. It's also the recommended security type.
 - **WPA /WPA2-Enterprise** - It's based on Radius Server.
 - **WEP** - It is based on the IEEE 802.11 standard.
- **Version** - Keep default version value.
- **Encryption** - Select **Auto**, **TKIP** or **AES**. We recommend you keep the default settings.
- **Transmit Power** - Select **High**, **Middle** or **Low** to specify the data transmit power. The default and recommended setting is **High**.
- **Channel Width** - This field determines which operating frequency will be used. It is not necessary to change the wireless channel unless you notice interference problems with another nearby access point. If you select auto, then AP will choose the best channel automatically.
- **Channel** - This field determines which operating frequency will be used. The default channel is set to **Auto**. It is not necessary to change the wireless channel unless you notice interference problems with another nearby access point.
- **Mode** - You can choose the appropriate "Mixed" mode.

4.3.2. Guest Network

Guest Network allows you to provide Wi-Fi access for guests without disclosing your host network. When you have guests in your house, apartment, or workplace, you can create a guest network for them. In addition, you can customize guest network settings to ensure network security and privacy.

- **Create a Guest Network**

1. Visit <http://tplinkwifi.net>, and log in with the password you set for the router.
2. Go to [Wireless](#) or [Advanced > Wireless > Guest Network](#).
3. Enable the [Guest Network](#) function.

Guest Network
Create a separate network for your guests to ensure network security and privacy.

2.4GHz: Enable [Sharing Network](#)

Network Name (SSID): Hide SSID

Security: ▼

Password:

4. Create a network name for your guest network.
5. Select the [Security](#) type and create the [Password](#) of the guest network.
6. Click [SAVE](#). Now you guests can access your guest network using the SSID and password you set!

- **Customize Guest Network Options**

1. Visit <http://tplinkwifi.net>, and log in with the password you set for the router.
2. Go to [Advanced > Wireless > Guest Network](#). Locate the [Guest Permissions](#) section.
3. Customize guest network options according to your needs.

Guest Permissions
Control the data that guests can access.

Allow guests to see each other

Allow guests to access your local network

- [Allow guests to see each other](#)

Tick this checkbox if you want to allow the wireless clients on your guest network to communicate with each other via methods such as network neighbors and Ping.

- [Allow guests to access my local network](#)

Tick this checkbox if you want to allow the wireless clients on your guest network to communicate with the devices connected to your router's LAN ports or main network via methods such as network neighbors and Ping.

4. Click [SAVE](#). Now you can ensure network security and privacy!

4.3.3. Wireless Schedule

The wireless function can be automatically off at a specific time when you do not need the wireless function.

1. Visit <http://tplinkwifi.net>, and log in with the password you set for the router.
2. Go to [Advanced](#) > [Wireless](#) > [Wireless Schedule](#).
3. Enable the [Wireless Schedule](#) function.

4. Click [Add](#) to specify a wireless off period during which you need the wireless off automatically, and click [SAVE](#).

Note:

- The effective wireless schedule is based on the time of the router. You can go to [Advanced](#) > [System](#) > [Time](#) to modify the time.
- The wireless network will be automatically turned on after the time period you set.

4.3.4. WPS

WPS (Wi-Fi Protected Setup) can help you to quickly and securely connect to a network. This section will guide you to add a new wireless device to your router's network quickly via WPS.

Note:

The WPS function cannot be configured if the wireless function of the router is disabled. Please make sure the wireless function is enabled before configuration.

1. Visit <http://tplinkwifi.net>, and log in with the password you set for the router.
2. Go to [Advanced](#) > [Wireless](#) > [WPS](#).
3. Follow one of the following three methods to connect your client device to the router's Wi-Fi network.

Method 1: Using a PIN

- **Connects via the Client's PIN**

1. Keep the WPS Status as [Enabled](#) and select [Client's PIN](#).

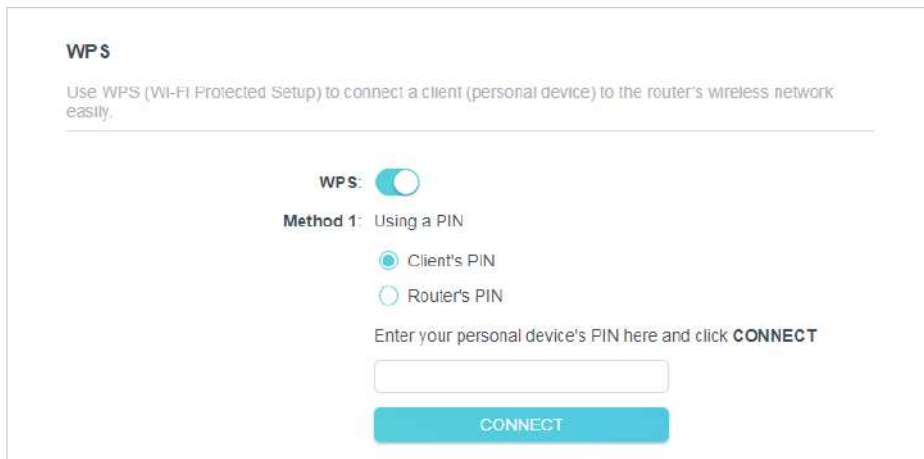

WPS

Use WPS (Wi-Fi Protected Setup) to connect a client (personal device) to the router's wireless network easily.

WPS:

Method 1: Using a PIN

Client's PIN

Router's PIN

Enter your personal device's PIN here and click **CONNECT**

CONNECT

2. Enter the PIN of your device and click [CONNECT](#). Then your device will get connected to the router.

• Connects vis the Router's PIN

1. Keep the WPS Status as **Enabled** and select **Router's PIN**.

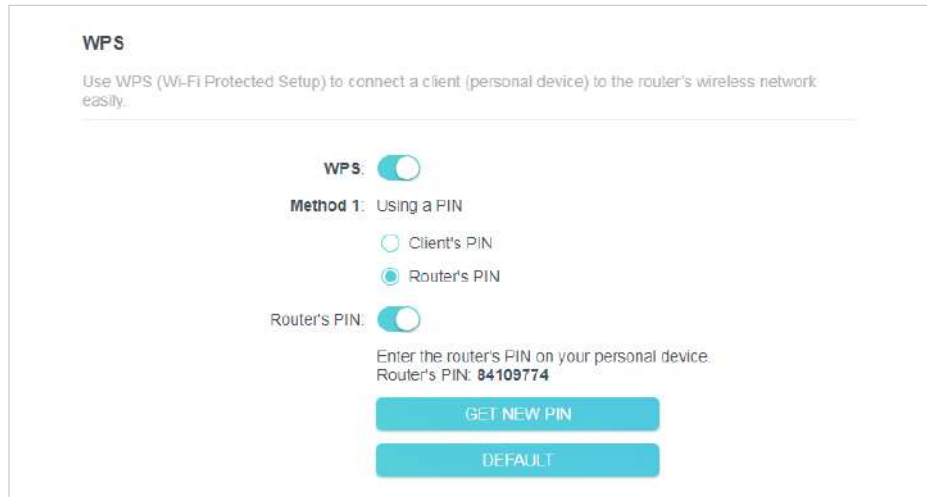

2. Enter the PIN on your personal device. You can use the default PIN or generate a new one.

Note:

PIN (Personal Identification Number) is an eight-character identification number preset to each router. WPS supported devices can connect to your router with the PIN. The default PIN is printed on the label of your router.

Method 2: Using the device's WPS button

Click **Start** on the screen. Within two minutes, press the WPS button on your device. A **Device-(XX-XX-XX-XX-XX-XX) Connected** message should appear on the screen and the  LED should change from blinking to solid on, indicating successful WPS connection.

Note:

XX-XX-XX-XX-XX-XX is the MAC address of your device.

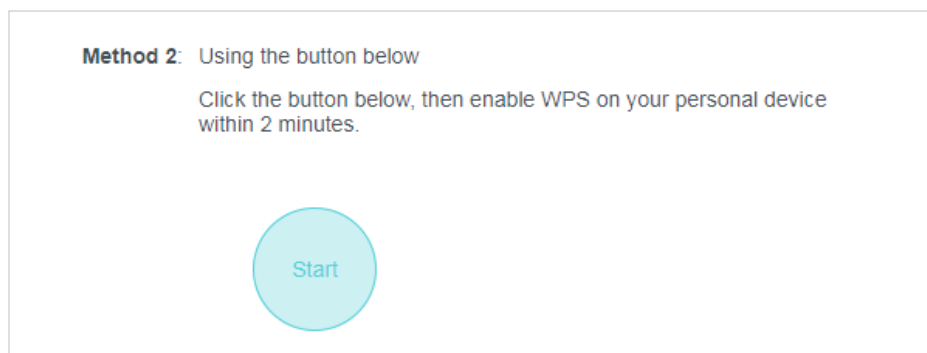

Method 3: Using the router's WPS button

Press the router's WPS button, then enable WPS on your personal device within 2 minutes.

4.3.5. Additional Wireless Settings

1. Visit <http://tplinkwifi.net>, and log in with the password you set for the router.
2. Go to [Advanced > Wireless > Additional Settings](#).
3. Configure the advanced settings of your wireless network and click [Save](#).

Note:

If you are not familiar with the setting items on this page, it's strongly recommended to keep the provided default values; otherwise it may result in lower wireless network performance.

Additional Settings
Check advanced wireless settings for your device.

WMM: Enable
Short GI: Enable
AP Isolation: Enable

Beacon Interval:
RTS Threshold:
DTIM Interval:
Group Key Update Period: s

- **Enable WMM** - WMM function can guarantee the packets with high-priority messages being transmitted preferentially. It is strongly recommended to enable this function.
- **Enable Short GI** - It is recommended to enable this function, for it will increase the data capacity by reducing the guard interval time.
- **AP Isolation** - This function isolates all connected wireless stations so that wireless stations cannot access each other through WLAN.
- **Beacon Interval** - Enter a value between 40-1000 milliseconds for Beacon Interval here. Beacon Interval value determines the time interval of the beacons. The beacons are the packets sent by the router to synchronize a wireless network. The default value is 100.
- **RTS Threshold** - Here you can specify the RTS (Request to Send) Threshold. If the packet is larger than the specified RTS Threshold size, the router will send RTS frames to a particular receiving station and negotiate the sending of a data frame. The default value is 2346.
- **DTIM Interval** - This value determines the interval of the Delivery Traffic Indication Message (DTIM). A DTIM field is a countdown field informing clients of the next window for listening to broadcast and multicast messages. When the router has buffered broadcast or multicast messages for associated clients, it sends the next DTIM with a DTIM Interval value. You can specify the value between 1-255 Beacon Intervals. The default value is 1, which indicates the DTIM Interval is the same as Beacon Interval.

- **Group Key Update Period** - Enter a number of seconds (minimum 30) to control the time interval for the encryption key automatic renewal. The default value is 0, meaning no key renewal.

4. 4. NAT Forwarding

The router's NAT (Network Address Translation) feature makes the devices on the LAN use the same public IP address to communicate on the internet, which protects the local network by hiding IP addresses of the devices. However, it also brings about the problem that external hosts cannot initiatively communicate with the specified devices in the local network.

With the forwarding feature, the router can traverse the isolation of NAT so that clients on the internet can reach devices on the LAN and realize some specific functions.

The TP-Link router includes four forwarding rules. If two or more rules are set, the priority of implementation from high to low is Port Forwarding, Port Triggering, UPNP and DMZ.

4. 4. 1. Port Forwarding

When you build up a server in the local network and want to share it on the internet, Port Forwarding can realize the service and provide it to internet users. At the same time Port Forwarding can keep the local network safe as other services are still invisible from the internet.

Port Forwarding can be used to set up public services in your local network, such as HTTP, FTP, DNS, POP3/SMTP and Telnet. Different service uses different service port. Port 80 is used in HTTP service, port 21 in FTP service, port 25 in SMTP service and port 110 in POP3 service. Please verify the service port number before the configuration.

I want to:

Share my personal website I've built in local network with my friends through the internet.

For example, the personal website has been built in my home PC (192.168.0.100). I hope that my friends on the internet can visit my website in some way. My PC is connected to the router with the WAN IP address 218.18.232.154.

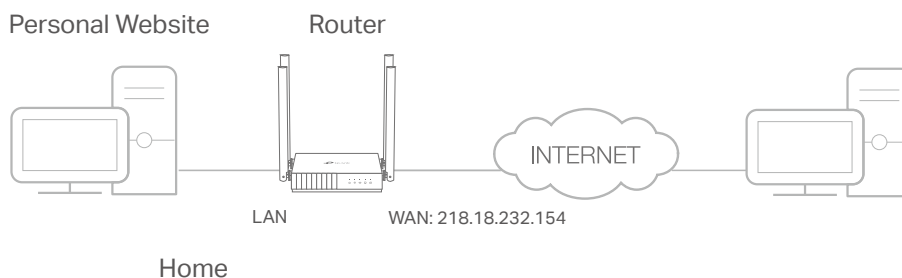

1. Set your PC to a static IP address, for example 192.168.0.100.
2. Visit <http://tplinkwifi.net>, and log in with the password you set for the router.
3. Go to **Advanced > NAT Forwarding > Port Forwarding**.
4. Click **Add**.

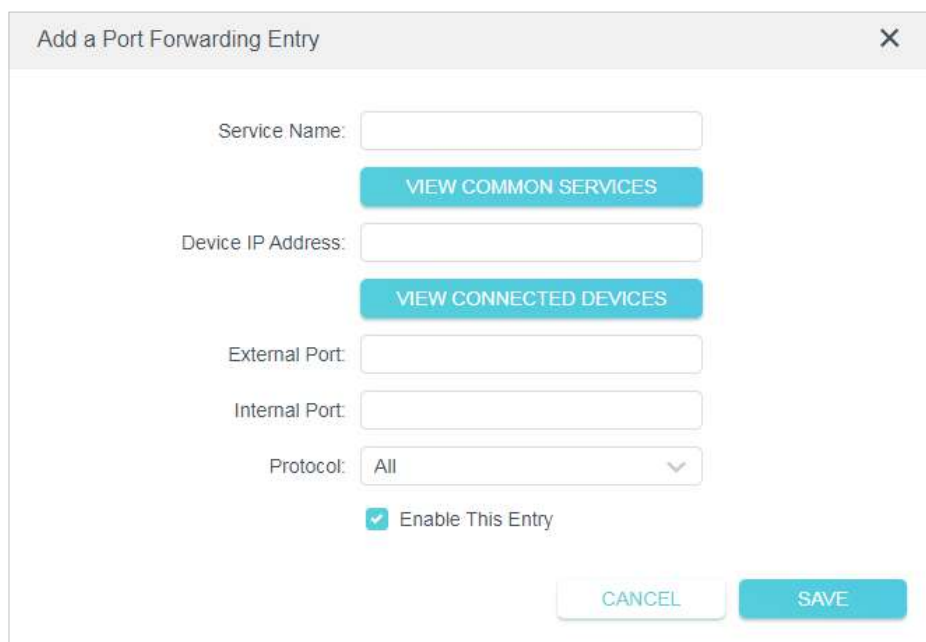

The screenshot shows a dialog box titled "Add a Port Forwarding Entry" with a close button (X) in the top right corner. The dialog contains the following fields and buttons:

- Service Name:** A text input field with a button labeled "VIEW COMMON SERVICES" below it.
- Device IP Address:** A text input field with a button labeled "VIEW CONNECTED DEVICES" below it.
- External Port:** A text input field.
- Internal Port:** A text input field.
- Protocol:** A dropdown menu currently set to "All".
- Enable This Entry**
- CANCEL** and **SAVE** buttons at the bottom right.

5. Click **VIEW COMMON SERVICES** and select **HTTP**. The **External Port**, **Internal Port** and **Protocol** will be automatically filled in.
6. Click **VIEW CONNECTED DEVICES** and select your home PC. The **Device IP Address** will be automatically filled in. Or enter the PC's IP address 192.168.0.100 manually in the **Device IP Address** field.
7. Click **SAVE**.

Note:

- It is recommended to keep the default settings of **Internal Port** and **Protocol** if you are not clear about which port and protocol to use.
- If the service you want to use is not in the **Common Services** list, you can enter the corresponding parameters manually. You should verify the port number that the service needs.
- You can add multiple virtual server rules if you want to provide several services in a router. Please note that the **External Port** should not be overlapped.

Done!

Users on the internet can enter [http:// WAN IP](http://WAN IP) (in this example: [http:// 218.18.232.154](http://218.18.232.154)) to visit your personal website.

Note:

- If you have changed the default **External Port**, you should use [http:// WAN IP: External Port](http://WAN IP: External Port) to visit the website.
- The WAN IP should be a public IP address. For the WAN IP is assigned dynamically by the ISP, it is recommended to apply and register a domain name for the WAN referring to [Dynamic DNS](#). Then users on the internet can use [http:// domain name](http://domain name) to visit the website.

4.4.2. Port Triggering

Port triggering can specify a triggering port and its corresponding external ports. When a host in the local network initiates a connection to the triggering port, all the external ports will be opened for subsequent connections. The router can record the IP address of the host. When the data from the internet return to the external ports, the router can forward them to the corresponding host. Port triggering is mainly applied to online games, VoIPs, video players and common applications including MSN Gaming Zone, Dialpad, Quick Time 4 players and more.

Follow the steps below to configure the port triggering rules:

1. Visit <http://tplinkwifi.net>, and log in with the password you set for the router.
2. Go to **Advanced > NAT Forwarding > Port Triggering**.
3. Click **Add**.
4. Click **VIEW COMMON SERVICES**, and select the desired application. The **Triggering Port**, **Triggering Protocol** and **External Port** will be automatically filled in. The following picture takes application **MSN Gaming Zone** as an example.

The screenshot shows a dialog box titled "Add a Port Triggering Entry" with a close button (X) in the top right corner. The dialog contains the following fields and controls:

- Service Name:** A text input field containing "MSN Gaming Zone".
- VIEW COMMON SERVICES:** A blue button located below the Service Name field.
- Triggers Port:** A text input field containing "47624".
- Triggers Protocol:** A dropdown menu with "All" selected.
- External Port:** A text input field containing "2300-2400,28800-29000". Below this field is a note: "(XX or XX-XX, 1-65535, at most 5 pairs)".
- External Protocol:** A dropdown menu with "All" selected.
- Enable This Entry:** A checkbox that is checked.
- CANCEL:** A light blue button at the bottom right.
- SAVE:** A blue button at the bottom right.

5. Click **SAVE**.

Note:

- You can add multiple port triggering rules as needed.
- The triggering ports can not be overlapped.
- If the application you need is not listed in the **Common Services** list, please enter the parameters manually. You should verify the external ports the application uses first and enter them in **External Ports** field. You can input at most 5 groups of ports (or port sections). Every group of ports must be set apart with ",". For example, 2000-2038, 2050-2051, 2085, 3010-3030.

4.4.3. DMZ

When a PC is set to be a DMZ (Demilitarized Zone) host in the local network, it is totally exposed to the internet, which can realize the unlimited bidirectional communication between internal hosts and external hosts. The DMZ host becomes a virtual server with all ports opened. When you are not clear about which ports to open in some special applications, such as IP camera and database software, you can set the PC to be a DMZ host.

Note:

DMZ is more applicable in the situation that users are not clear about which ports to open. When it is enabled, the DMZ host is totally exposed to the internet, which may bring some potential safety hazards. If DMZ is not in use, please disable it in time.

I want to:

Make the home PC join the internet online game without port restriction.

For example, due to some port restriction, when playing the online games, you can log in normally but cannot join a team with other players. To solve this problem, set your PC as a DMZ host with all ports opened.

How can I do that?

1. Assign a static IP address to your PC, for example 192.168.0.100.
2. Visit <http://tplinkwifi.net>, and log in with the password you set for the router.
3. Go to **Advanced > NAT Forwarding > DMZ** and select **Enable**.
4. Click **VIEW CONNECTED DEVICES** and select your PC. The **DMZ Host IP Address** will be automatically filled in. Or enter the PC's IP address 192.168.0.100 manually in the **DMZ Host IP Address** field.

DMZ

Expose a specific device in your local network to the internet for applications such as online gaming and real-time communications.

DMZ: Disabled Enable DMZ

DMZ Host IP Address:

[VIEW CONNECTED DEVICES](#)

5. Click **SAVE**.

Done!

You've set your PC to a DMZ host and now you can make a team to game with other players.

4.4.4. UPnP

The UPnP (Universal Plug and Play) protocol allows the applications or host devices to automatically find the front-end NAT device and send request to it to open the corresponding ports. With UPnP enabled, the applications or host devices on the local network and the internet can freely communicate with each other realizing the seamless connection of the network. You may need to enable the UPnP if you want to use applications for multiplayer gaming, peer-to-peer connections, real-time communication (such as VoIP or telephone conference) or remote assistance, etc.

☞ **Tips:**

- UPnP is enabled by default in this router.
- Only the application supporting UPnP protocol can use this feature.
- UPnP feature needs the support of operating system (e.g. Windows Vista/ Windows 7/ Windows 8, etc. Some of operating system need to install the UPnP components).

For example, when you connect your Xbox to the router which is connected to the internet to play online games, UPnP will send request to the router to open the corresponding ports allowing the following data penetrating the NAT to transmit. Therefore, you can play Xbox online games without a hitch.

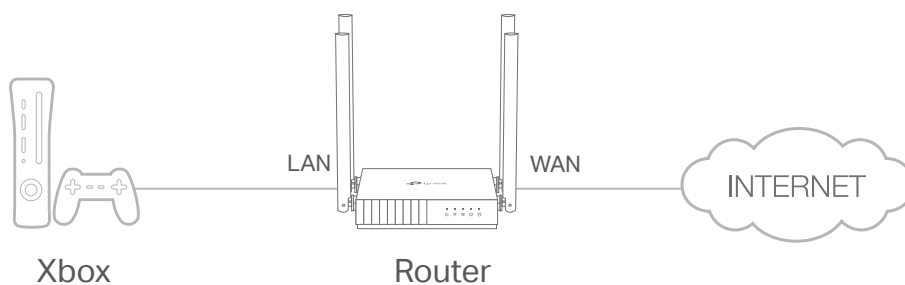

If necessary, you can follow the steps to change the status of UPnP.

1. Visit <http://tplinkwifi.net>, and log in with the password you set for the router.
2. Go to **Advanced > NAT Forwarding > UPnP** and toggle on or off according to your needs.

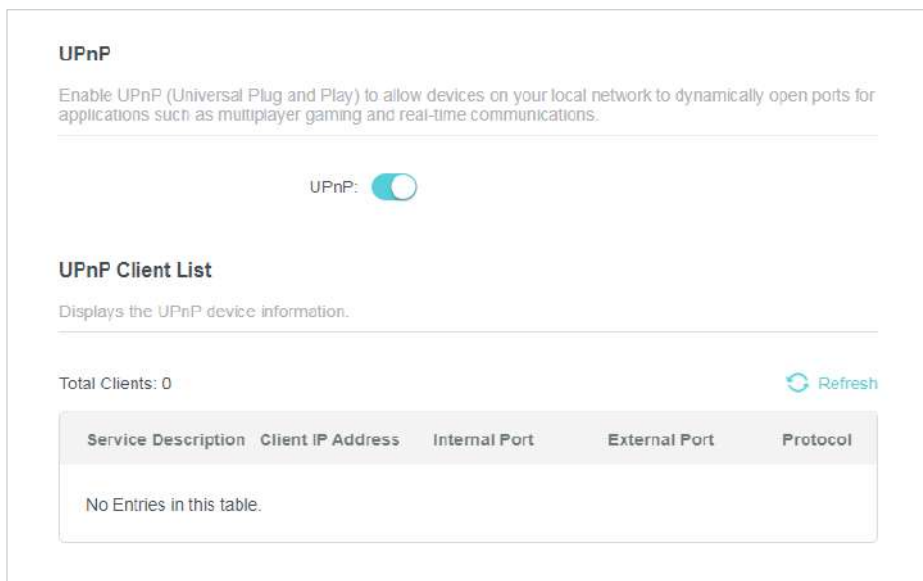

4.5. Parental Controls

Parental Controls allows you to set up unique restrictions on internet access for each member of your family. You can block inappropriate content, set daily limits for the total time spent online and restrict internet access to certain times of the day.

I want to:

Block access to inappropriate online content for my child's devices, restrict internet access to 2 hours every day and block internet access during bed time (10 PM to 7 AM) on weekdays.

How can I do that?

1. Visit <http://tplinkwifi.net>, and log in with the password you set for the router.
2. Go to [Advanced](#) > [Parental Controls](#).
3. Click [Add](#) to create a profile for a family member.

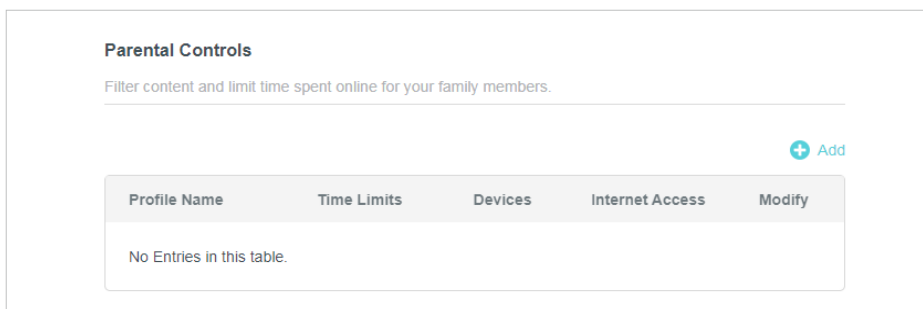

4. Add basic profile information.

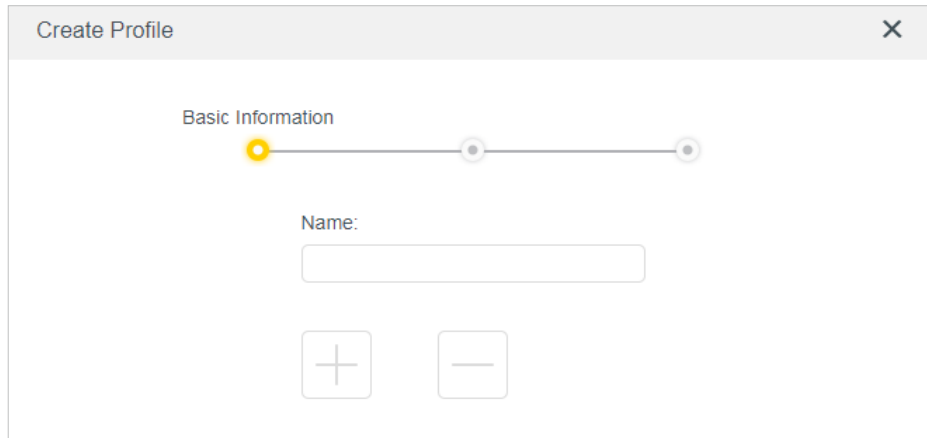

- 1) Enter a **Name** for the profile to make it easier to identify.
- 2) Under **Devices**, click .
- 3) Select the devices that belong to this family member. Access restrictions will be applied to these devices. Click **ADD** when finished.

Note: Only devices that have previously been connected to your router's network are listed here. If you are unable to find the device you want to add, connect it to your network and then try again.

- 4) Click **NEXT**.

5. Block content for this profile.

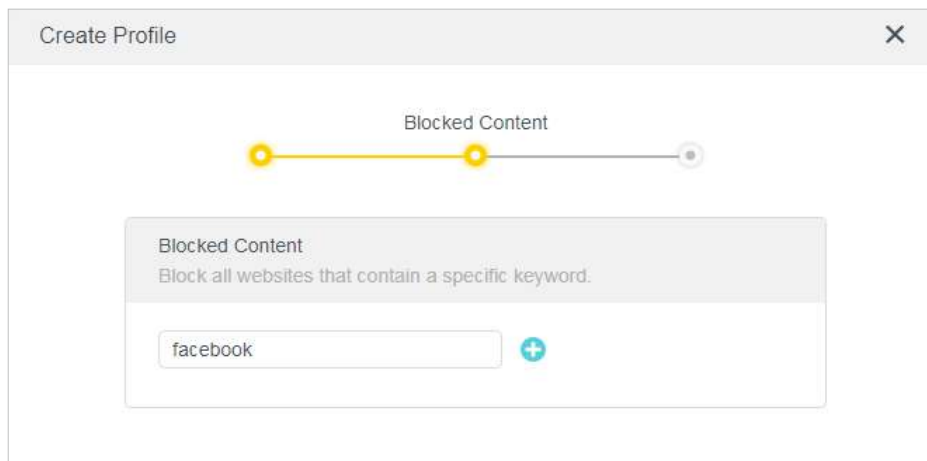

- 1) Enter the key word of the website that you want to block. Click if want to block multiple websites.
- 2) Click **NEXT**.

6. Set time restrictions on internet access.

The screenshot shows a 'Create Profile' window with a progress bar at the top. Below the progress bar, there are two main sections: 'Time Limits' and 'Bed Time'.

Time Limits
 Set daily time limits for the total time spent online.

Mon to Fri:
 Daily Time Limit: 1 hours

Sat & Sun:
 Daily Time Limit: 2 hours

Bed Time
 Block this person's internet access between certain times.

School Nights:
 (Sun to Thur)

Good Night: 10 : 00
 PM

Good Morning: 7 : 00
 AM

Weekend:
 (Fri & Sat)

- 1) Enable **Time Limits** on Monday to Friday and Saturday & Sunday then set the allowed online time to 2 hours each day.
- 2) Enable **Bed Time** on School Nights and use the up/down arrows or enter times in the fields. Devices under this profile will be unable to access the internet during this time period.
- 3) Click **SAVE**.

Note: The effective time limits are based on the time of the router. You can go to [Advanced > System > Time](#) to modify the time.

Done!

The amount of time your child spends online is controlled and inappropriate content is blocked on their devices.

4.6. QoS

QoS (Quality of Service) is designed to ensure the efficient operation of the network when come across network overload or congestion. Devices set as high priority will be

allocated more bandwidth and so continue to run smoothly even when there are many devices connected to the network.

I want to:

Ensure a fast connection of my computer while I play online games for the next 2 hours.

How can I do that

1. Visit <http://tplinkwifi.net>, and log in with the password you set for the router.
2. Go to [Advanced > QoS](#).
3. Tick the [Enable](#) checkbox of [QoS](#).
4. Enter the maximum upload and download bandwidths provided by your internet service provider, and then click [SAVE](#). 1Mbps equals to 1,000Kbps.
5. Find your computer in the [Device Priority](#) section and toggle on [Priority](#). Select 2 hours from the drop-down list of [Timing](#). Your computer will be prioritized for the next 2 hours.

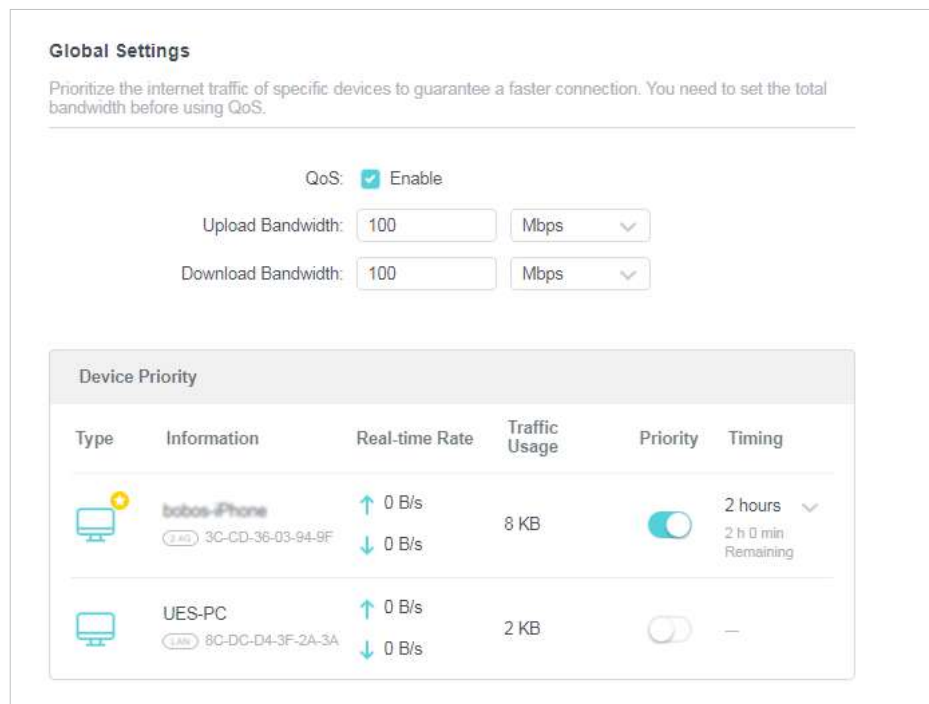

Done!

You can now enjoy playing games without lag on your computer for the next 2 hours.

4.7. Security

This function allows you to protect your home network from cyber attacks and unauthorized users by implementing these network security functions.

4.7.1. Firewall

The SPI (Stateful Packet Inspection) Firewall protects the router from cyber attacks and validate the traffic that is passing through the router based on the protocol. This function is enabled by default.

1. Visit <http://tplinkwifi.net>, and log in with the password you set for the router.
2. Go to **Advanced > Security > Firewall**, and configure the parameters as you need. It's recommended to keep the default settings.

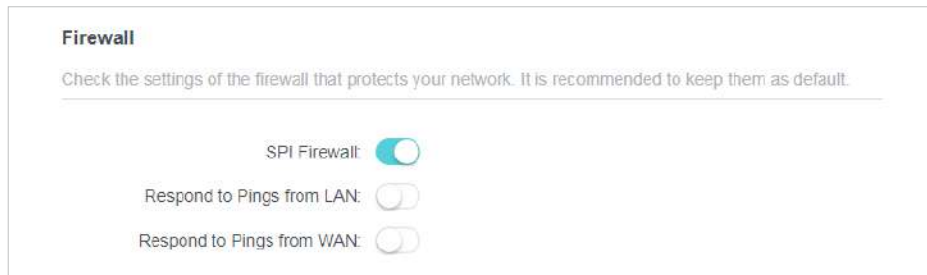

4.7.2. Access Control

Access Control is used to block or allow specific client devices to access your network (via wired or wireless) based on a list of blocked devices (Blacklist) or a list of allowed devices (Whitelist).

I want to:

Block or allow specific client devices to access my network (via wired or wireless).

How can I do that?

1. Visit <http://tplinkwifi.net>, and log in with the password you set for the router.
2. Go to **Advanced > Security > Access Control**:
3. Select the access mode to either block (recommended) or allow the device(s) in the list.

To block specific device(s):

- 1) Select **Blacklist** and click **SAVE**.

Access Control

Control the access to your network from the specified devices.

Access Control:

Access Mode: Blacklist
 Configure a blacklist to only block access to your network from the specified devices.



Whitelist

[+ Add](#)

Device Type	Device Name	MAC Address	Modify
No Entries in this table.			

- 2) Click [Add](#) and select devices you want to be blocked. You can see the devices have been added to the blacklist.

[+ Add](#)

Device Type	Device Name	MAC Address	Modify
	Unknown	38-37-8b-49-57-ff	

To allow specific device(s):

- 1) Select [Whitelist](#) and click [SAVE](#).

Access Control

Control the access to your network from the specified devices.

Access Control:

Access Mode: Blacklist
 Configure a blacklist to only block access to your network from the specified devices.

Whitelist
 Configure a whitelist to only allow access to your network from the specified devices.

[+ Add](#)

Device Type	Device Name	MAC Address	Modify
No Entries in this table.			

- 2) Add devices to the whitelist.

- **Add connected devices**

Click [Select From Device List](#) and select the devices you want to be allowed.

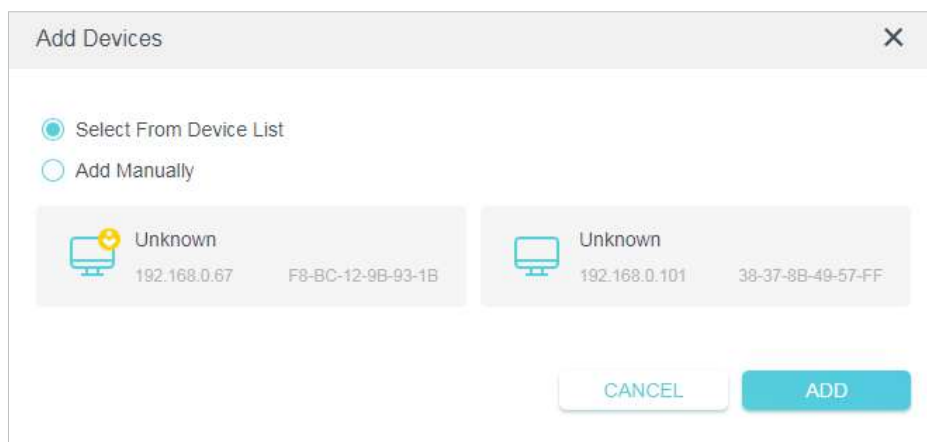

- **Add unconnected devices**

Click [Add Manually](#) and enter the [Device Name](#) and [MAC Address](#) of the device you want to be allowed.

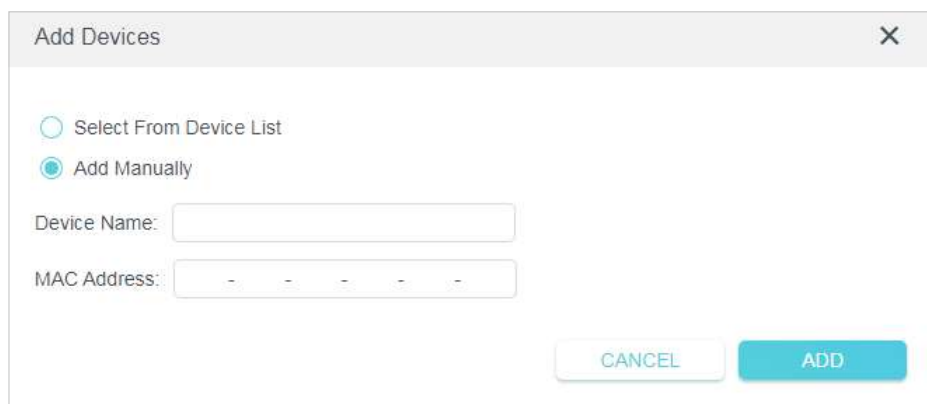

Done!

Now you can block or allow specific client devices to access your network (via wired or wireless) using the [Blacklist](#) or [Whitelist](#).

4.7.3. IP & MAC Binding

IP & MAC Binding, namely, ARP (Address Resolution Protocol) Binding, is used to bind network device's IP address to its MAC address. This will prevent ARP Spoofing and other ARP attacks by denying network access to an device with matching IP address in the Binding list, but unrecognized MAC address.

I want to:

Prevent ARP spoofing and ARP attacks.

How can I do that?

1. Visit <http://tplinkwifi.net>, and log in with the password you set for the router.

2. Go to [Advanced](#) > [Security](#) > [IP & MAC Binding](#).
3. Enable [IP & MAC Binding](#) and click [SAVE](#).

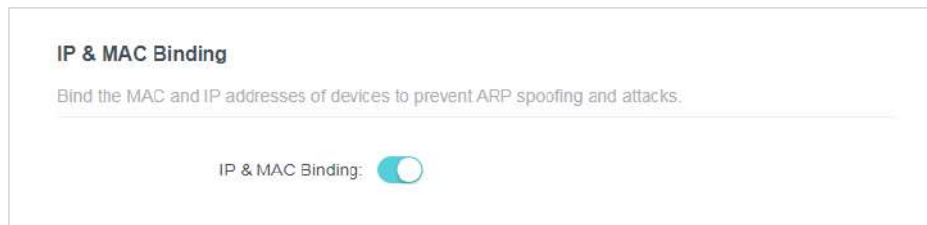

4. Bind your device(s) according to your need.

To bind the connected device(s):

Locate the [ARP List](#) section and enable Bind to bind the IP and MAC addresses of a specific device.



To add a binding entry:

- 1) Click [Add](#) in the [Binding List](#) section.
- 2) Click [VIEW CONNECTED DEVICES](#) and select the device you want to bind. Or enter the [MAC Address](#) and [IP Address](#) that you want to bind.
- 3) Click [ADD](#).

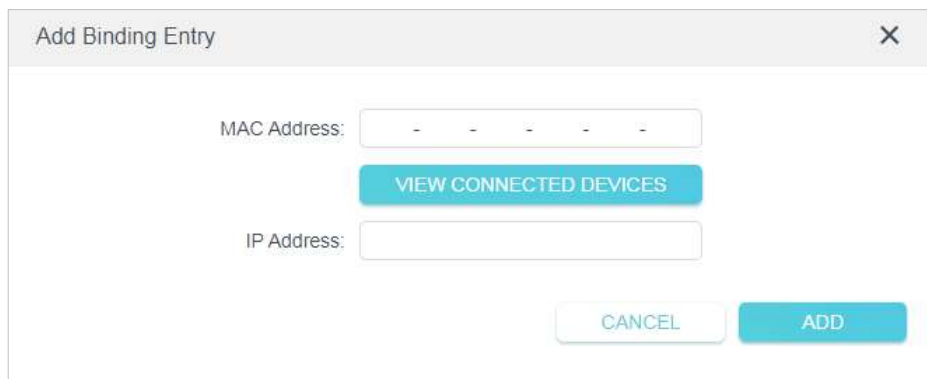

4. 8. ALG (Application Layer Gateway)

View your ALG (Application Layer Gateway) settings in this page. It is recommended to keep them as default.

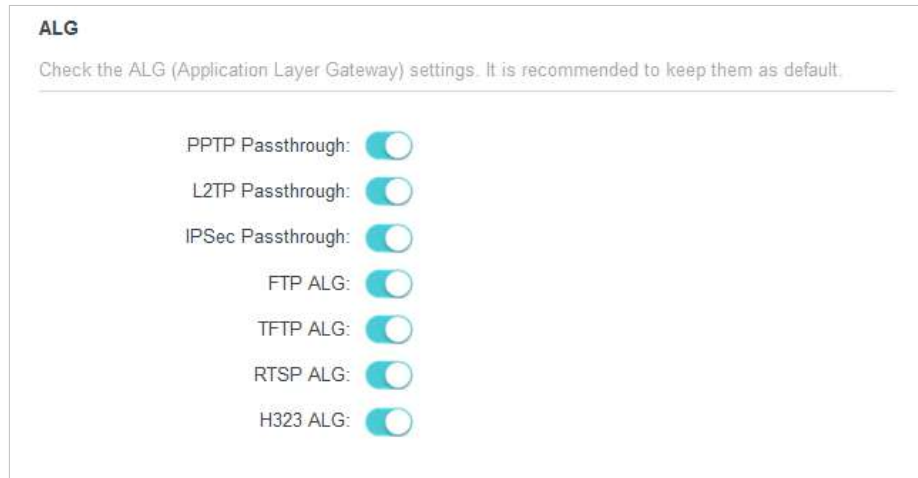

ALG

Check the ALG (Application Layer Gateway) settings. It is recommended to keep them as default.

PPTP Passthrough:

L2TP Passthrough:

IPSec Passthrough:

FTP ALG:

TFTP ALG:

RTSP ALG:

H323 ALG:

4. 9. IPv6

This function allows you to enable IPv6 function and set up the parameters of the router's Wide Area Network (WAN) and Local Area Network (LAN).

4. 9. 1. IPv6 Status

1. Visit <http://tplinkwifi.net>, and log in with the password you set for the router.
 2. Go to **Advanced > IPv6**, and you can view the current IPv6 status information of the router.
 3. Enable IPv6 and select the mode: Router or Pass-Through (Bridge).
- If you select **Router**:

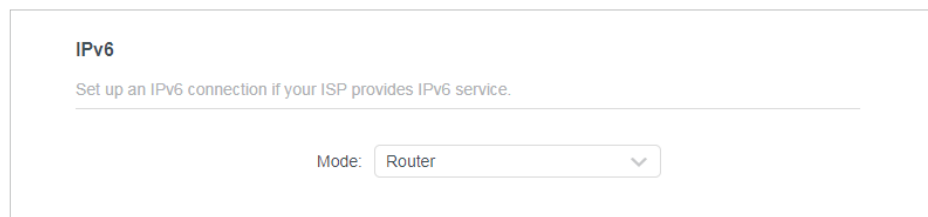

IPv6

Set up an IPv6 connection if your ISP provides IPv6 service.

Mode:

Fill in WAN and LAN information as required by different connection types.

1. **Normal**: The default connection type.

- 1) Configure the WAN settings.

WAN

Configure the WAN connection based on your network typology.

WAN Connection Type: Normal

Get IPv6 Address: Auto

Manually set DNS server

Link-Local Address:

Global Address:

Gateway:

Primary DNS:

Secondary DNS:

2) Configure the LAN settings. Fill in [Address Prefix](#) provided by your ISP.

LAN

Configure the LAN IPv6 address of the router.

Enable Prefix Delegation

Address Prefix:

Prefix Length: 0

Link-Local Address:

Prefix:

Connect

Disconnect

3) Click [SAVE](#).

2. **PPPoE:** Select this type if your ISP uses PPPoEv6, and provides a username and password.

1) Configure the WAN settings.

WAN

Configure the WAN connection based on your network typology.

WAN Connection Type:

Get IPv6 Address:

Use the same PPPoE session as IPv4 ?

Username:

Password:

Manually set DNS server

Link-Local Address:

Global Address:

Gateway:

Primary DNS:

Secondary DNS:

2) Configure the LAN settings. Fill in [Address Prefix](#) provided by your ISP.

LAN

Configure the LAN IPv6 address of the router.

Enable Prefix Delegation

Address Prefix:

Prefix Length:

Link-Local Address:

Prefix:

3. **Tunnel 6to4**: Select this type if your ISP uses 6 to 4 deployment fort assigning address.

1) Configure the WAN settings.

WAN

Configure the WAN connection based on your network typology.

WAN Connection Type:

Manually set DNS server

Link-Local Address:

Global Address:

Gateway:

Primary DNS:

Secondary DNS:

2) Configure the LAN settings.

LAN

Configure the LAN IPv6 address of the router.

Link-Local Address:

Prefix:

[Connect](#)

[Disconnect](#)

- If you select **Pass-Through (Bridge)**:
Click **SAVE**. No configuration is required.

IPv6

Set up an IPv6 connection if your ISP provides IPv6 service.

Mode:

Select this type if your ISP uses Pass-Through (Bridge) network deployment.

4. 10. System

4. 10. 1. Firmware Upgrade

TP-Link is dedicated to improving and enriching the product features, giving users a better network experience. We will release the latest firmware at TP-Link official website www.tp-link.com. You can download the latest firmware file from the [Support](#) page of our website and upgrade the firmware to the latest version.

1. Download the latest firmware file for the router from our website www.tp-link.com.
2. Visit <http://tplinkwifi.net>, and log in with the password you set for the router.
3. Go to [Advanced](#) > [System](#) > [Firmware Upgrade](#).
4. Click [BROWSE](#) to locate the downloaded firmware file, and click [UPGRADE](#).

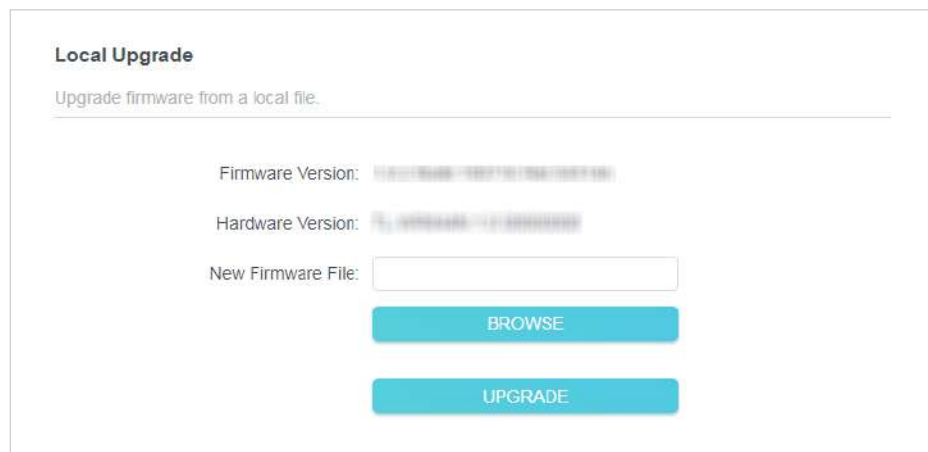

The screenshot shows the 'Local Upgrade' section of the router's web interface. It includes a title 'Local Upgrade', a subtitle 'Upgrade firmware from a local file.', and two status fields: 'Firmware Version: V1.0.0.0000-00000000000000000000' and 'Hardware Version: V1.0.0.0000-00000000000000000000'. Below these is a text input field for 'New Firmware File:' with a 'BROWSE' button underneath it. At the bottom of the section is a large 'UPGRADE' button.

4. 10. 2. Backup & Restore

The configuration settings are stored as a configuration file in the router. You can backup the configuration file in your computer for future use and restore the router to the previous settings from the backup file when needed.

1. Visit <http://tplinkwifi.net>, and log in with the password you set for the router.
2. Go to [Advanced](#) > [System](#) > [Backup & Restore](#).

- **To backup configuration settings:**

Click [BACK UP](#) to save a copy of the current settings in your local computer. A ".bin" file of the current settings will be stored in your computer.

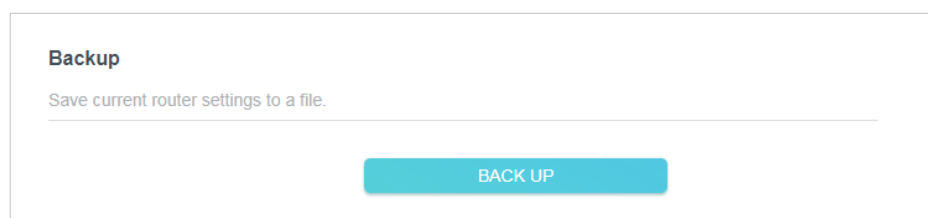

The screenshot shows the 'Backup' section of the router's web interface. It includes a title 'Backup', a subtitle 'Save current router settings to a file.', and a large 'BACK UP' button at the bottom.

- **To restore configuration settings:**

1. Click **BROWSE** to locate the backup configuration file stored in your computer, and click **RESTORE**.
2. Wait a few minutes for the restoring and rebooting.

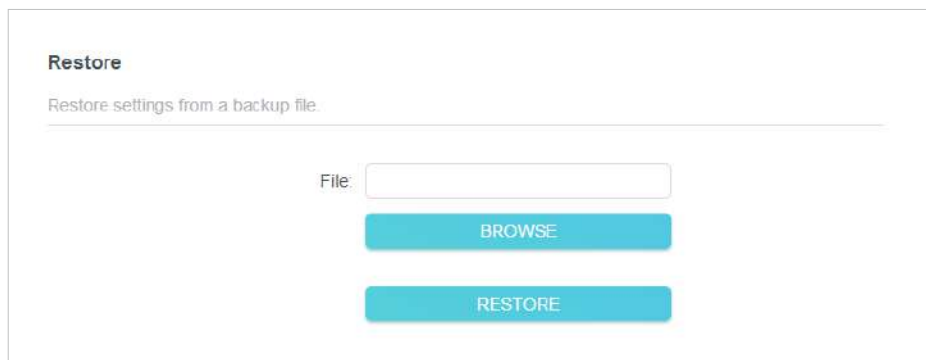

The screenshot shows a web interface titled "Restore". Below the title is the instruction "Restore settings from a backup file." followed by a horizontal line. Underneath, there is a "File:" label next to an empty text input field. Below the input field are two teal buttons: "BROWSE" and "RESTORE".

- **To reset the router to factory default settings:**

1. Click **FACTORY RESTORE** to reset the router.



The screenshot shows a web interface titled "Factory Default Restore". Below the title is the instruction "Restore all settings to default values." followed by a horizontal line. Below the line is a single teal button labeled "FACTORY RESTORE".

2. Wait a few minutes for the restoring and rebooting.

■ **Note:**

- During the resetting process, do not turn off or reset the router.
- We strongly recommend you backup the current configuration settings before resetting the router.

4. 10. 3. Change Password

1. Visit <http://tplinkwifi.net>, and log in with the password you set for the router.
2. Go to **Advanced > System > Administration**, and focus on the **Change Password** section.

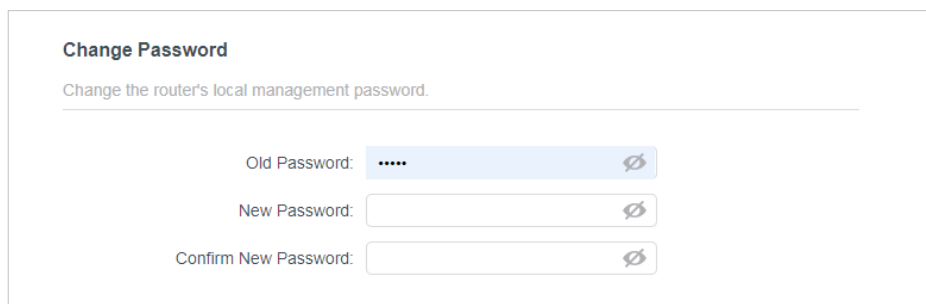

The screenshot shows a web interface titled "Change Password". Below the title is the instruction "Change the router's local management password." followed by a horizontal line. Below the line are three password input fields: "Old Password:" with a masked password "...." and a toggle icon; "New Password:" with an empty field and a toggle icon; and "Confirm New Password:" with an empty field and a toggle icon.

3. Enter the old password, then a new password twice (both case-sensitive). Click **SAVE**.
4. Use the new password for future logins.

4. 10. 4. Local Management

1. Visit <http://tplinkwifi.net>, and log in with the password you set for the router.
2. Go to [Advanced](#) > [System](#) > [Administration](#), and focus on the [Local Management](#) section.

- **Allow all LAN connected devices to manage the router:**

Select [All Devices](#) for [Local Managers](#).

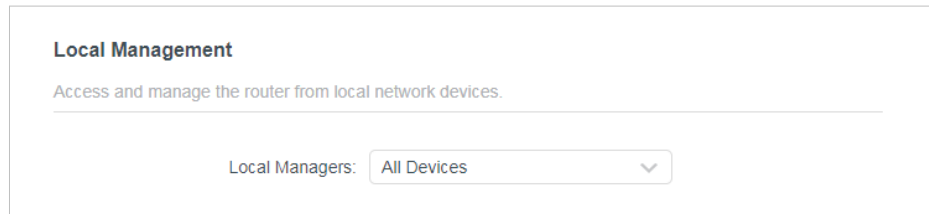

Local Management
Access and manage the router from local network devices.

Local Managers:

- **Allow specific devices to manage the router:**

1. Select [All Devices](#) for [Local Managers](#) and click [SAVE](#).

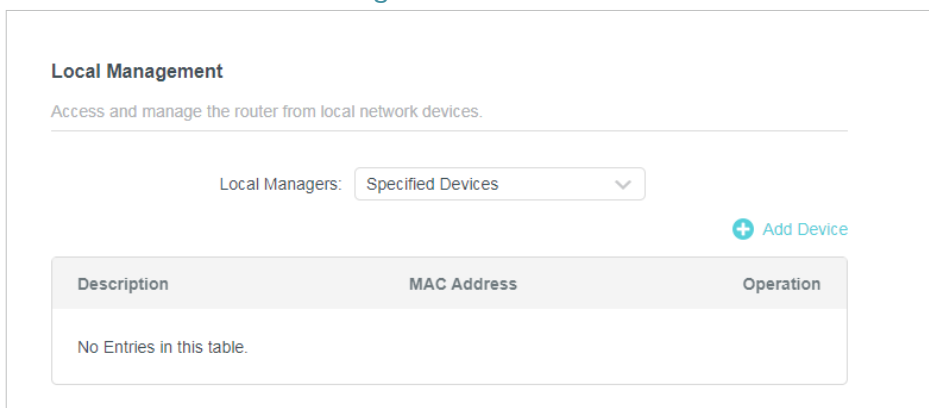

Local Management
Access and manage the router from local network devices.

Local Managers:

[+ Add Device](#)

Description	MAC Address	Operation
No Entries in this table.		

2. Click [Add Device](#).

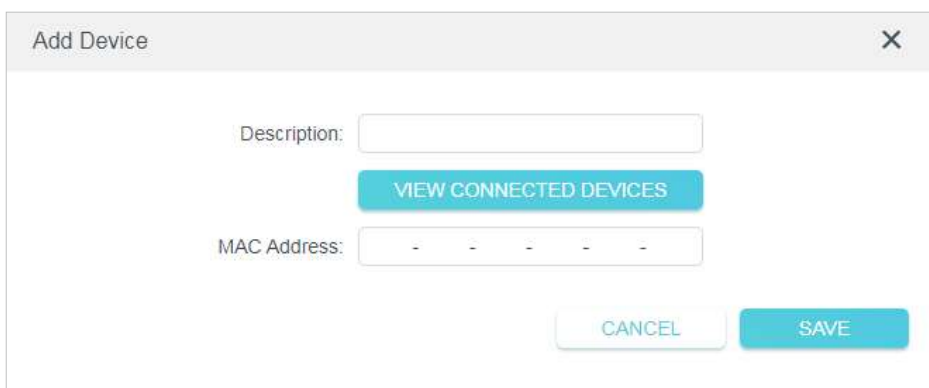

Add Device ✕

Description:

[VIEW CONNECTED DEVICES](#)

MAC Address:

[CANCEL](#) [SAVE](#)

3. Click [VIEW CONNECTED DEVICES](#) and select the device to manage the router from the Connected Devices list, or enter the MAC address of the device manually.
4. Specify a [Description](#) for this entry.
5. Click [SAVE](#).

4. 10. 5. Remote Management

1. Visit <http://tplinkwifi.net>, and log in with the password you set for the router.
2. Go to **Advanced > System > Administration**, and focus on the **Remote Management** section.

Note:

If your ISP assigns a private WAN IP address (such as 192.168.x.x or 10.x.x.x), you cannot use this feature because private addresses are not routable.

- **Forbid all devices to manage the router remotely:**

Do not tick the **Enable** checkbox of **Remote Management**.

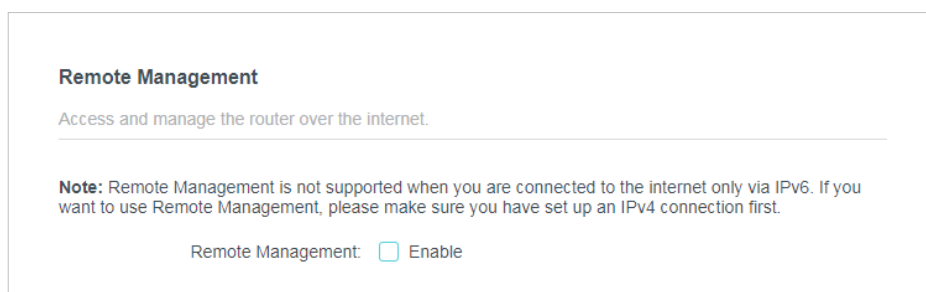

Remote Management

Access and manage the router over the internet.

Note: Remote Management is not supported when you are connected to the internet only via IPv6. If you want to use Remote Management, please make sure you have set up an IPv4 connection first.

Remote Management: Enable

- **Allow all devices to manage the router remotely:**

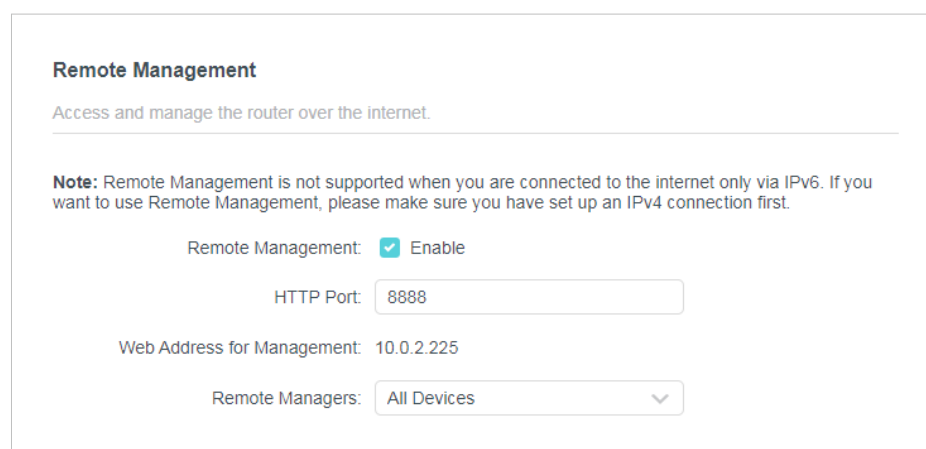

Remote Management

Access and manage the router over the internet.

Note: Remote Management is not supported when you are connected to the internet only via IPv6. If you want to use Remote Management, please make sure you have set up an IPv4 connection first.

Remote Management: Enable

HTTP Port:

Web Address for Management: 10.0.2.225

Remote Managers:

1. Tick the **Enable** checkbox of **Remote Management**.
2. Keep the HTTP port as default setting (recommended) or enter a value between 1024 and 65535.
3. Select **All Devices** for **Remote Managers**.
4. Click **SAVE**.

Devices on the internet can log in to <http://Router's WAN IP address: port number> (such as <http://113.116.60.229:1024>) to manage the router.

Tips:

- You can find the WAN IP address of the router on **Network Map > Internet**.

- The router's WAN IP is usually a dynamic IP. Please refer to [Dynamic DNS](#) if you want to log in to the router through a domain name.
- **Allow a specific device to manage the router remotely:**

Remote Management

Access and manage the router over the internet.

Note: Remote Management is not supported when you are connected to the internet only via IPv6. If you want to use Remote Management, please make sure you have set up an IPv4 connection first.

Remote Management: Enable

HTTP Port:

Web Address for Management: 10.0.2.225

Remote Managers:

Only this IP Address:

1. Tick the **Enable** checkbox of **Remote Management**.
2. Keep the HTTP port as default setting (recommended) or enter a value between 1024 and 65535.
3. Select **Specified Device** for **Remote Managers**.
4. In the **Only this IP Address** field, enter the IP address of the remote device to manage the router.
5. Click **SAVE**.

Devices using this WAN IP can manage the router by logging in to <http://Router's WAN IP:port number> (such as <http://113.116.60.229:1024>).

 **Tips:** The router's WAN IP is usually a dynamic IP. Please refer to [Dynamic DNS](#) if you want to log in to the router through a domain name.

4. 10. 6. System Log

1. Visit <http://tplinkwifi.net>, and log in with the password you set for the router.
2. Go to **Advanced > System > System Log**, and you can view the logs of the router.

System Log

View a detailed record of system activities.

Current Time: 2019-09-02 09:21:46

Refresh
Clear All

```

1 WARNING 0days, 00:00:00, Invalid lan mac, now start by default mac 00-19-66-CA-8B-07.
2 INFO 0days, 00:00:00, LAN: Attach mirror0 to stack.
3 INFO 0days, 00:00:00, LAN: Set interface mirror0 ip=192.168.0.1 netmask 255.255.255.0.
4 INFO 0days, 00:00:00, HTTPD: Http server start!
5 INFO 0days, 00:00:05, WAN: Attach interface eth1.
6 INFO 0days, 00:00:07, WAN: Wan ethernet port plug on.
7 INFO 0days, 00:00:08, DHCPD: Send DISCOVER with unicast flag 0.
8 INFO 0days, 00:00:08, DHCPD: Recv OFFER from server 10.0.0.1 with ip 10.0.2.225.
9 INFO 0days, 00:00:08, DHCPD: Send REQUEST to server 10.0.0.1 with request ip 10.0.2.225.
10 INFO 0days, 00:00:08, DHCPD: eth1 set ip 10.0.2.225 mask 255.255.252.0 gateway 10.0.0.1.
11 INFO 0days, 00:00:08, WAN: advanced odns -wanChanged
12 INFO 0days, 00:07:26, DHCPD: Send ACK to 192.168.0.101.

```

Save Log

Save system log locally.

SAVE TO LOCAL

3. Click **SAVE TO LOCAL** to save the system logs to a local disk.

4. 10. 7. Diagnostic

Diagnostic is used to test the connectivity between the router and the host or other network devices.

1. Visit <http://tplinkwifi.net>, and log in with the password you set for the router.
2. Go to **Advanced > System > Diagnostics**.

Diagnostics

Troubleshoot network connectivity problems.

Diagnostic Tools: Ping

IP Address/Domain Name:

Ping Packet Number:

Ping Packet Size: Bytes

START

3. Enter the information:

- 1) Choose **Ping** or **Tracert** as the diagnostic tool to test the connectivity;
 - **Ping** is used to test the connectivity between the router and the tested host, and measure the round-trip time.

- **Tracert** is used to display the route (path) your router has passed to reach the tested host, and measure transit delays of packets across an Internet Protocol network.
- 2) Enter the **IP Address** or **Domain Name** of the tested host.
 - 3) Modify the **Ping Count** number and the **Ping Packet Size**. It's recommended to keep the default value.
 - 4) If you have chosen **Tracert**, you can modify the **Traceroute Max TTL**. It's recommended to keep the default value.

4. Click **START** to begin the diagnostics.

The figure below indicates the proper connection between the router and the Yahoo server (www.Yahoo.com) tested through **Ping**.

```
Finding host yahoo.com by DNS server (1 of 2).
Pinging yahoo.com [98.138.219.231] with 64 bytes of data:
Reply from 98.138.219.231: bytes=64 time=233ms TTL=48 (seq=0).
Reply from 98.138.219.231: bytes=64 time=233ms TTL=48 (seq=1).
Reply from 98.138.219.231: bytes=64 time=233ms TTL=48 (seq=2).
Reply from 98.138.219.231: bytes=64 time=233ms TTL=48 (seq=3).
Ping statistics for 98.138.219.231:
Packets: Sent = 4, Received = 4, Lost = 0 (0% loss).
Approximate round trip times in milli-seconds:
Minimum = 233ms, Maximum = 233ms, Average = 233ms
```

The figure below indicates the proper connection between the router and the Yahoo server (www.Yahoo.com) tested through **Tracert**.

```
Finding host yahoo.com by DNS server (1 of 2).
Tracing route to yahoo.com [72.30.35.10]
over a maximum of 30 hops:
 0  0 ms  0 ms  0 ms  10.0.0.1
 1  1 ms  1 ms  1 ms  116.24.64.1
 2  1 ms  1 ms  1 ms  202.105.155.185
 3  1 ms  1 ms  1 ms  183.56.65.2
 4  1 ms  1 ms  1 ms  202.97.94.150
 5  * 1 ms * 202.97.94.94
 6 16 ms 16 ms 16 ms 202.97.27.242
 7 150 ms 150 ms 150 ms 202.97.50.74
 8 166 ms 166 ms 166 ms 4.53.210.145
 9 150 ms 150 ms 150 ms
```

4. 10. 8. Time Settings

This page allows you to set the time manually or to configure automatic time synchronization. The router can automatically update the time from an NTP server via the internet.

1. Visit <http://tplinkwifi.net>, and log in with the password you set for the router.
2. Go to **Advanced > System > Time**.

- **To set System Time:**

1. Select the way in which the router gets its time: Get from Internet, Get from Managing Device, Manually.
2. Select your local [Time Zone](#).
3. Enter the address or domain of the [NTP Server 1](#) or [NTP Server 2](#).
4. Click [SAVE](#).

- **To set up Daylight Saving Time:**

1. Select [Enable Daylight Saving](#).

2. Select the start time from the drop-down list in the [Start](#) fields.
3. Select the end time from the drop-down list in the [End](#) fields.
4. Click [SAVE](#).

Note:

This setting will be used for some time-based functions such as firewall. You must specify your time zone once you log in to the router successfully; otherwise, time-based functions will not take effect.

4. 10. 9. Reboot

Some settings of the router will take effect only after rebooting, and the system will reboot automatically. You can also reboot the router to clear cache and enhance running performance.

1. Visit <http://tplinkwifi.net>, and log in with the password you set for the router.
2. Go to [Advanced](#) > [System](#) > [Reboot](#), and you can restart your router.

- **To reboot the router manually:**

Click **REBOOT**, and wait a few minutes for the router to reboot.

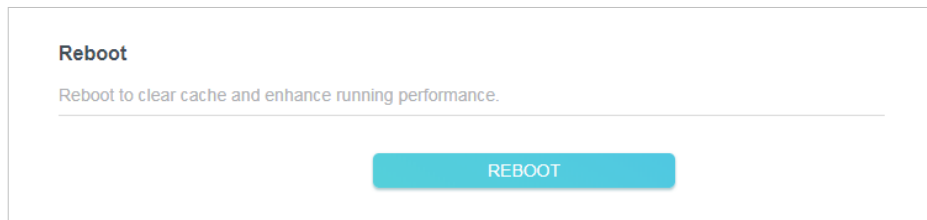

- **To set the router to reboot regularly:**

1. Tick the **Enable** box of [Reboot Schedule](#).
2. Specify the [Reboot Time](#) when the router reboots and [Repeat](#) to decide how often it reboots.
3. Click **SAVE**.

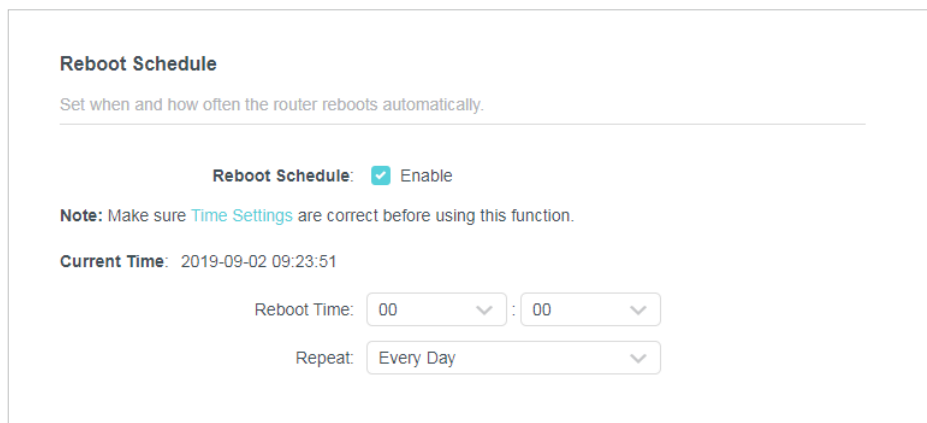

4. 10. 10. LED Control

The LED of the router indicates its activities and status. You can enable the Night Mode feature to specify a time period during which the LED is off.

1. Visit <http://tplinkwifi.net>, and log in with the password you set for the router.
2. Go to [Advanced](#) > [System](#) > [LED Control](#).
3. Enable [Night Mode](#).

LED Control

Turn the router's LEDs on or off.

LED Status:

Night Mode

Set a time period when the LEDs will be off automatically.

Night Mode: Enable

Note: Make sure [Time Settings](#) are correct before using this function.

Current Time: 2019-09-02 09:24:35

LED Off From: 23 : 00

To: 06 : 00 (next day)

4. Specify the LED off time, and the LED will be off during this period every day.

Note: The effective LED off time is based on the time of the router. You can go to [Advanced > System > Time & Language](#) to modify the time.

5. Click **SAVE**.

Chapter 5

Configure the Router in Access Point Mode

This chapter presents how to configure the various features of the router working as an access point.

It contains the following sections:

- [Operation Mode](#)
- [Firmware Upgrade](#)
- [Backup & Restore](#)
- [Administration](#)
- [System Log](#)
- [Diagnostic](#)
- [Time Settings](#)
- [Reboot](#)
- [LED Control](#)

5.1. Operation Mode

1. Visit <http://tplinkwifi.net>, and log in with the password you set for the router.
2. Go to **System > Operation Mode**.
3. Select the working mode as needed and click **SAVE**.

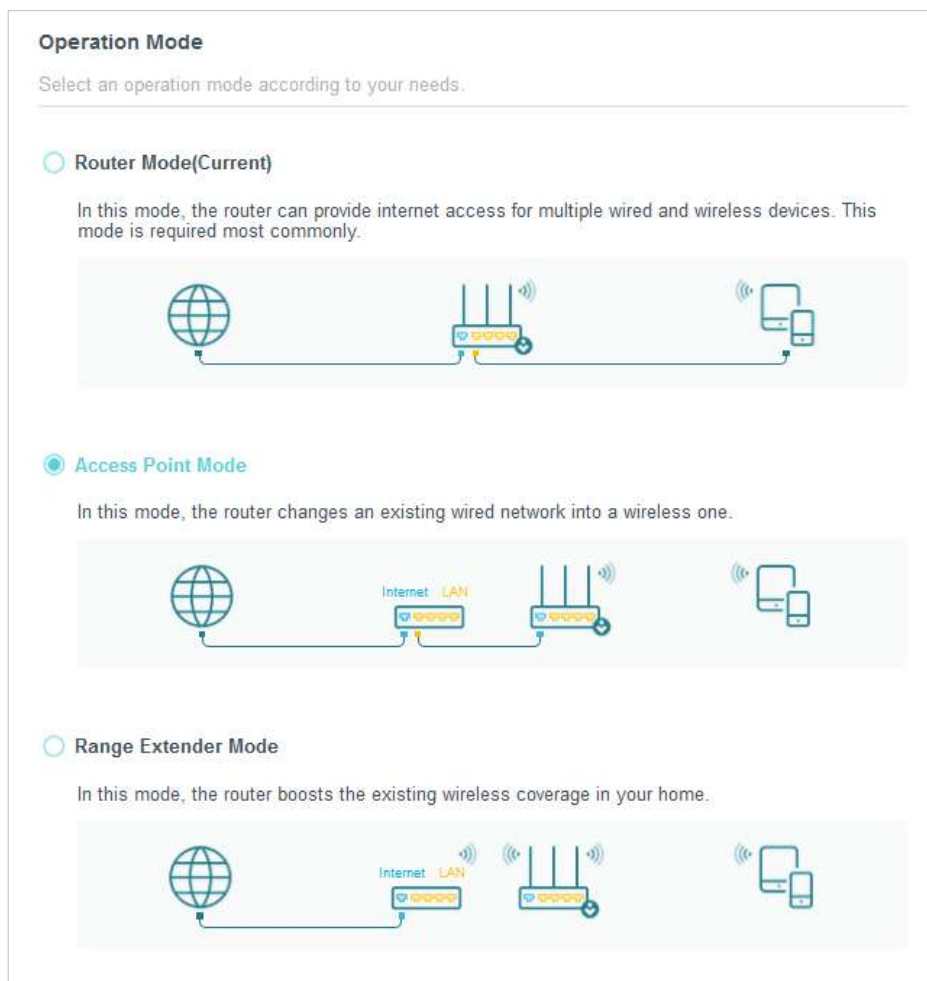

5.2. Firmware Upgrade

TP-Link is dedicated to improving and enriching the product features, giving users a better network experience. We will release the latest firmware at TP-Link official website www.tp-link.com. You can download the latest firmware file from the **Support** page of our website and upgrade the firmware to the latest version.

1. Download the latest firmware file for the router from our website www.tp-link.com.
2. Visit <http://tplinkwifi.net>, and log in with the password you set for the router.
3. Go to **System > Firmware Upgrade**.
4. Click **BROWSE** to locate the downloaded firmware file, and click **UPGRADE**.

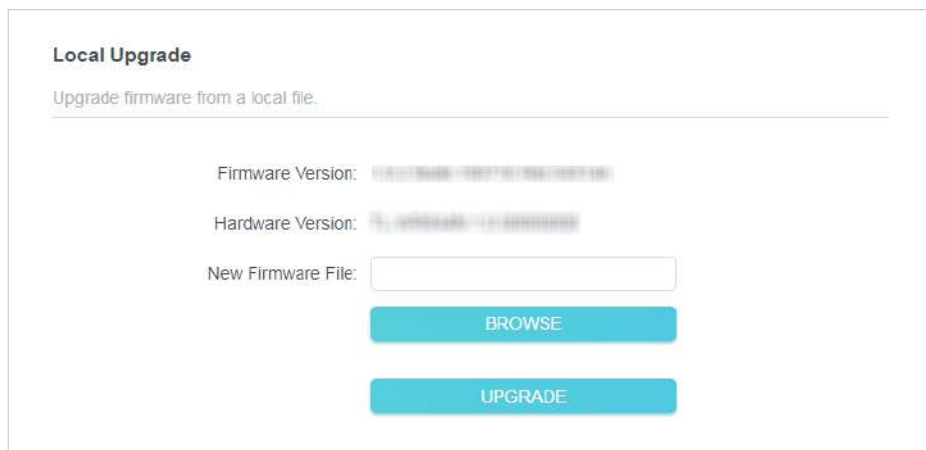

The screenshot shows the 'Local Upgrade' section of the router's web interface. It features a title 'Local Upgrade' and a subtitle 'Upgrade firmware from a local file.' Below this, there are two read-only fields: 'Firmware Version' and 'Hardware Version'. A text input field labeled 'New Firmware File:' is followed by a blue 'BROWSE' button. Below that is a blue 'UPGRADE' button.

5.3. Backup & Restore

The configuration settings are stored as a configuration file in the router. You can backup the configuration file in your computer for future use and restore the router to the previous settings from the backup file when needed.

1. Visit <http://tplinkwifi.net>, and log in with the password you set for the router.
2. Go to [System > Backup & Restore](#).

- **To backup configuration settings:**

Click **BACK UP** to save a copy of the current settings in your local computer. A ".bin" file of the current settings will be stored in your computer.

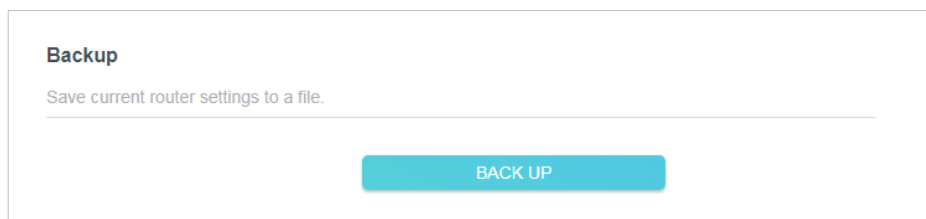

The screenshot shows the 'Backup' section of the router's web interface. It features a title 'Backup' and a subtitle 'Save current router settings to a file.' Below this is a blue 'BACK UP' button.

- **To restore configuration settings:**

1. Click **BROWSE** to locate the backup configuration file stored in your computer, and click **RESTORE**.
2. Wait a few minutes for the restoring and rebooting.

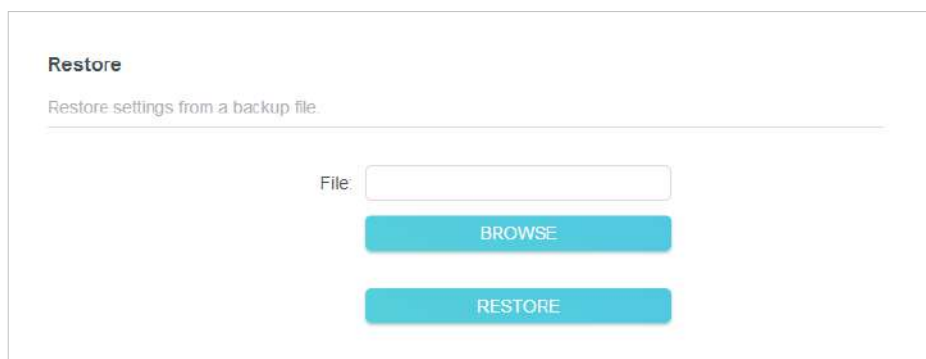

The screenshot shows the 'Restore' section of the router's web interface. It features a title 'Restore' and a subtitle 'Restore settings from a backup file.' Below this is a text input field labeled 'File:' followed by a blue 'BROWSE' button. Below that is a blue 'RESTORE' button.

- **To reset the router to factory default settings:**

1. Click **FACTORY RESTORE** to reset the router.



Factory Default Restore
Restore all settings to default values.

FACTORY RESTORE

2. Wait a few minutes for the restoring and rebooting.

Note:

- During the resetting process, do not turn off or reset the router.
- We strongly recommend you backup the current configuration settings before resetting the router.

5.4. Administration

5.4.1. Change Password

1. Visit <http://tplinkwifi.net>, and log in with the password you set for the router.
2. Go to **System > Administration**, and focus on the **Change Password** section.

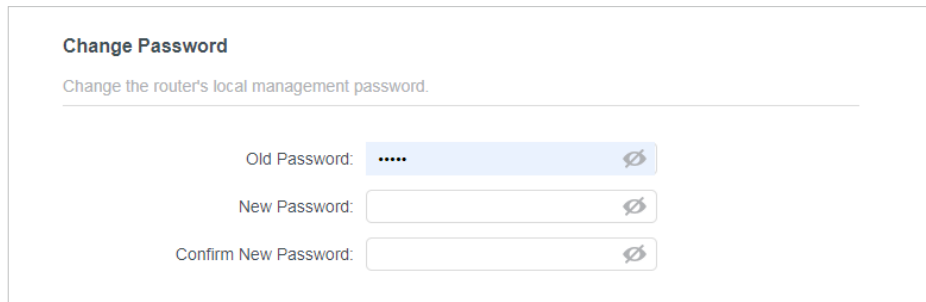

Change Password
Change the router's local management password.

Old Password: 

New Password: 

Confirm New Password: 

3. Enter the old password, then a new password twice (both case-sensitive). Click **SAVE**.
4. Use the new password for future logins.

5.4.2. Local Management

1. Visit <http://tplinkwifi.net>, and log in with the password you set for the router.
2. Go to **System > Administration**, and focus on the **Local Management** section.

- **Allow all LAN connected devices to manage the router:**

Select **All Devices** for **Local Managers**.

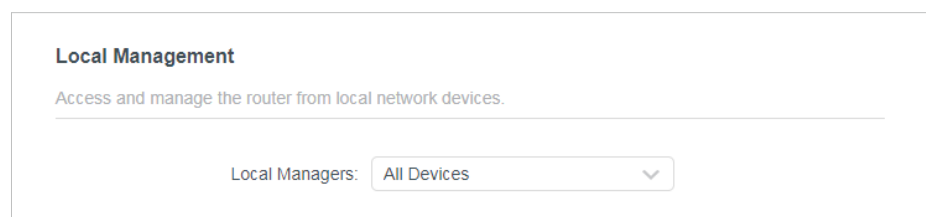

Local Management
Access and manage the router from local network devices.

Local Managers: 

- **Allow specific devices to manage the router:**

1. Select **All Devices** for **Local Managers** and click **SAVE**.

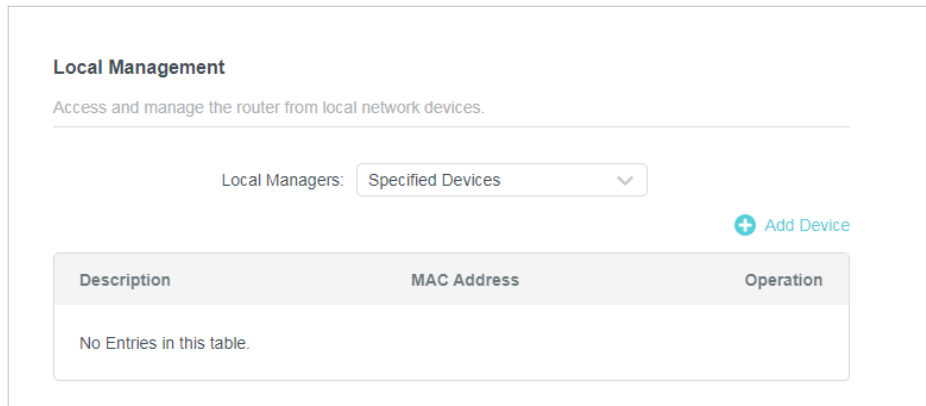

The screenshot shows the 'Local Management' configuration page. At the top, it says 'Local Management' and 'Access and manage the router from local network devices.' Below this, there is a dropdown menu for 'Local Managers' currently set to 'Specified Devices'. To the right of the dropdown is a '+ Add Device' button. Below the dropdown is a table with three columns: 'Description', 'MAC Address', and 'Operation'. The table is currently empty, with the text 'No Entries in this table.' displayed inside.

2. Click **Add Device**.

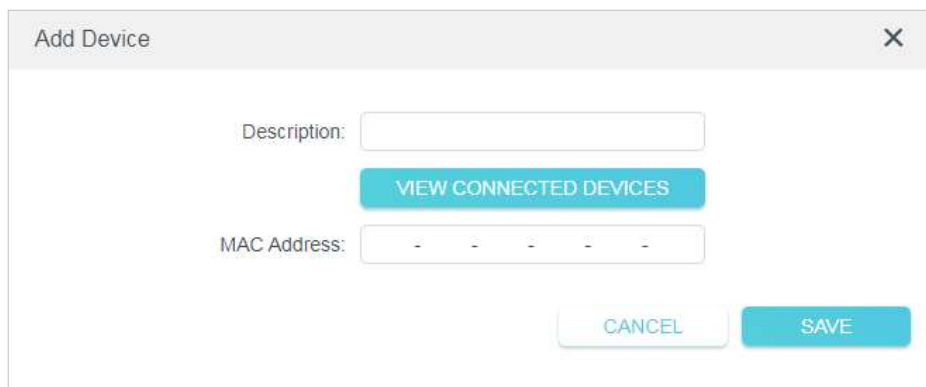

The screenshot shows the 'Add Device' dialog box. It has a title bar with 'Add Device' and a close button (X). Inside the dialog, there is a 'Description:' label followed by a text input field. Below the description field is a blue button labeled 'VIEW CONNECTED DEVICES'. Below that is a 'MAC Address:' label followed by a text input field containing five dashes. At the bottom right of the dialog are two buttons: 'CANCEL' and 'SAVE'.

3. Click **VIEW CONNECTED DEVICES** and select the device to manage the router from the Connected Devices list, or enter the MAC address of the device manually.

4. Specify a **Description** for this entry.

5. Click **SAVE**.

5.5. System Log

1. Visit <http://tplinkwifi.net>, and log in with the password you set for the router.

2. Go to **System > System Log**, and you can view the logs of the router.

System Log

View a detailed record of system activities.

Current Time: 2019-09-02 09:21:46

Refresh
Clear All

```

1 WARNING 0days, 00:00:00, Invalid lan mac, now start by default mac 00-19-66-CA-8B-07.
2 INFO 0days, 00:00:00, LAN: Attach mirror0 to stack.
3 INFO 0days, 00:00:00, LAN: Set interface mirror0 ip=192.168.0.1 netmask 255.255.255.0.
4 INFO 0days, 00:00:00, HTTPD: Http server start!
5 INFO 0days, 00:00:05, WAN: Attach interface eth1.
6 INFO 0days, 00:00:07, WAN: Wan ethernet port plug on.
7 INFO 0days, 00:00:08, DHCPD: Send DISCOVER with unicast flag 0.
8 INFO 0days, 00:00:08, DHCPD: Recv OFFER from server 10.0.0.1 with ip 10.0.2.225.
9 INFO 0days, 00:00:08, DHCPD: Send REQUEST to server 10.0.0.1 with request ip 10.0.2.225.
10 INFO 0days, 00:00:08, DHCPD: eth1 set ip 10.0.2.225 mask 255.255.252.0 gateway 10.0.0.1.
11 INFO 0days, 00:00:08, WAN: advanced odns -wanChanged
12 INFO 0days, 00:07:26, DHCPD: Send ACK to 192.168.0.101.

```

Save Log

Save system log locally.

SAVE TO LOCAL

3. Click **SAVE TO LOCAL** to save the system logs to a local disk.

5.6. Diagnostic

Diagnostic is used to test the connectivity between the router and the host or other network devices.

1. Visit <http://tplinkwifi.net>, and log in with the password you set for the router.
2. Go to **System > Diagnostics**.

Diagnostics

Troubleshoot network connectivity problems.

Diagnostic Tools: Ping ▼

IP Address/Domain Name:

Ping Packet Number:

Ping Packet Size: Bytes

START

3. Enter the information:

- 1) Choose **Ping** or **Tracert** as the diagnostic tool to test the connectivity;
 - **Ping** is used to test the connectivity between the router and the tested host, and measure the round-trip time.

- **Tracert** is used to display the route (path) your router has passed to reach the tested host, and measure transit delays of packets across an Internet Protocol network.
- 2) Enter the **IP Address** or **Domain Name** of the tested host.
 - 3) Modify the **Ping Count** number and the **Ping Packet Size**. It's recommended to keep the default value.
 - 4) If you have chosen **Tracert**, you can modify the **Traceroute Max TTL**. It's recommended to keep the default value.

4. Click **START** to begin the diagnostics.

The figure below indicates the proper connection between the router and the Yahoo server (www.Yahoo.com) tested through **Ping**.

```
Finding host yahoo.com by DNS server (1 of 2).
Pinging yahoo.com [98.138.219.231] with 64 bytes of data:
Reply from 98.138.219.231: bytes=64 time=233ms TTL=48 (seq=0).
Reply from 98.138.219.231: bytes=64 time=233ms TTL=48 (seq=1).
Reply from 98.138.219.231: bytes=64 time=233ms TTL=48 (seq=2).
Reply from 98.138.219.231: bytes=64 time=233ms TTL=48 (seq=3).
Ping statistics for 98.138.219.231:
Packets: Sent = 4, Received = 4, Lost = 0 (0% loss).
Approximate round trip times in milli-seconds:
Minimum = 233ms, Maximum = 233ms, Average = 233ms
```

The figure below indicates the proper connection between the router and the Yahoo server (www.Yahoo.com) tested through **Tracert**.

```
Finding host yahoo.com by DNS server (1 of 2).
Tracing route to yahoo.com [72.30.35.10]
over a maximum of 30 hops:
 0 1 ms 1 ms 1 ms 10.0.0.1
 1 1 ms 1 ms 1 ms 116.24.64.1
 2 1 ms 1 ms 1 ms 202.105.155.185
 3 1 ms 1 ms 1 ms 183.56.65.2
 4 * 1 ms * 202.97.94.150
 5 16 ms 16 ms 16 ms 202.97.94.94
 6 150 ms 150 ms 150 ms 202.97.27.242
 7 166 ms 166 ms 166 ms 202.97.50.74
 8 150 ms 150 ms 150 ms 4.53.210.145
```

5.7. Time Settings

This page allows you to set the time manually or to configure automatic time synchronization. The router can automatically update the time from an NTP server via the internet.

1. Visit <http://tplinkwifi.net>, and log in with the password you set for the router.
2. Go to **System > Time**.

- **To set System Time:**

System Time
Set the router's system time.

Current Time: 2019-09-02 09:22:39

24-Hour Time:

Set Time: Get from Internet

Time Zone: (GMT+00:00) Greenwich Mean Time: Dublin, I

NTP Server I: time.nist.gov

NTP Server II: time-nw.nist.gov (Optional)

1. Select the way in which the router gets its time: Get from Internet, Get from Managing Device, Manually.
2. Select your local [Time Zone](#).
3. Enter the address or domain of the [NTP Server 1](#) or [NTP Server 2](#).
4. Click [SAVE](#).

- **To set up Daylight Saving Time:**

1. Select [Enable Daylight Saving](#).

Daylight Saving Time
Automatically synchronize the system time with daylight saving time.

Daylight Saving Time: Enable

Start: 2019 Mar 2nd Sun 02:00

End: 2019 Nov First Sun 02:00

Running Status: Daylight Saving Time is off.

2. Select the start time from the drop-down list in the [Start](#) fields.
3. Select the end time from the drop-down list in the [End](#) fields.
4. Click [SAVE](#).

Note:

This setting will be used for some time-based functions such as firewall. You must specify your time zone once you log in to the router successfully; otherwise, time-based functions will not take effect.

5.8. Reboot

Some settings of the router will take effect only after rebooting, and the system will reboot automatically. You can also reboot the router to clear cache and enhance running performance.

1. Visit <http://tplinkwifi.net>, and log in with the password you set for the router.
2. Go to [System > Reboot](#), and you can restart your router.

- **To reboot the router manually:**

Click **REBOOT**, and wait a few minutes for the router to reboot.

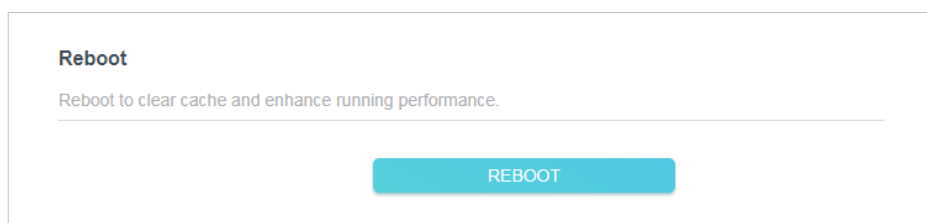

- **To set the router to reboot regularly:**

1. Tick the **Enable** box of [Reboot Schedule](#).
2. Specify the [Reboot Time](#) when the router reboots and [Repeat](#) to decide how often it reboots.
3. Click **SAVE**.

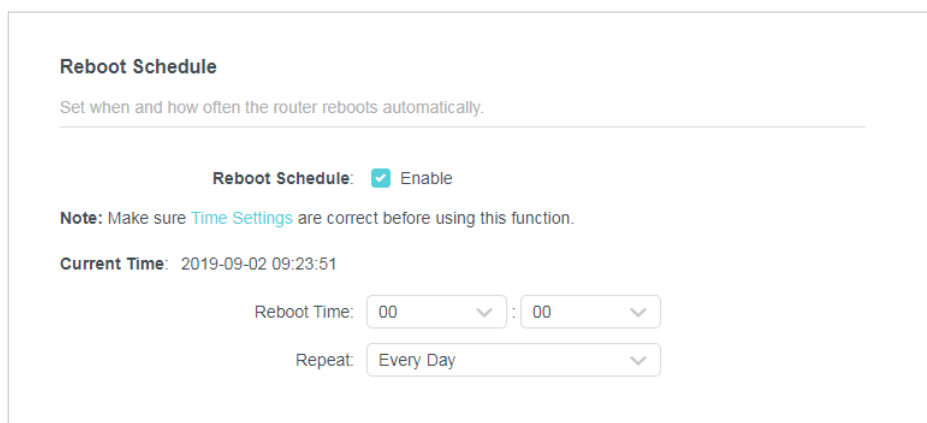

5.9. LED Control

The LED of the router indicates its activities and status. You can enable the Night Mode feature to specify a time period during which the LED is off.

1. Visit <http://tplinkwifi.net>, and log in with the password you set for the router.
2. Go to [System > LED Control](#).
3. Enable [Night Mode](#).

LED Control

Turn the router's LEDs on or off.

LED Status:

Night Mode

Set a time period when the LEDs will be off automatically.

Night Mode: Enable

Note: Make sure [Time Settings](#) are correct before using this function.

Current Time: 2019-09-02 09:24:35

LED Off From: 23 : 00

To: 06 : 00 (next day)

4. Specify the LED off time, and the LED will be off during this period every day.

Note: The effective LED off time is based on the time of the router. You can go to [Advanced > System > Time & Language](#) to modify the time.

5. Click **SAVE**.

Chapter 6

Configure the Router in Range Extender Mode

This chapter presents how to configure the various features of the router working as a range extender.

It contains the following sections:

- [Operation Mode](#)
- [Firmware Upgrade](#)
- [Backup & Restore](#)
- [Administration](#)
- [System Log](#)
- [Time Settings](#)
- [Reboot](#)
- [LED Control](#)

6.1. Operation Mode

1. Visit <http://tplinkwifi.net>, and log in with the password you set for the router.
2. Go to **System > Operation Mode**.
3. Select the working mode as needed and click **SAVE**.

Operation Mode

Select an operation mode according to your needs.

Router Mode(Current)

In this mode, the router can provide internet access for multiple wired and wireless devices. This mode is required most commonly.



Access Point Mode

In this mode, the router changes an existing wired network into a wireless one.



Range Extender Mode

In this mode, the router boosts the existing wireless coverage in your home.



6.2. Firmware Upgrade

TP-Link is dedicated to improving and enriching the product features, giving users a better network experience. We will release the latest firmware at TP-Link official website www.tp-link.com. You can download the latest firmware file from the **Support** page of our website and upgrade the firmware to the latest version.

1. Download the latest firmware file for the router from our website www.tp-link.com.
2. Visit <http://tplinkwifi.net>, and log in with the password you set for the router.
3. Go to **System > Firmware Upgrade**.
4. Click **BROWSE** to locate the downloaded firmware file, and click **UPGRADE**.

6.3. Backup & Restore

The configuration settings are stored as a configuration file in the router. You can backup the configuration file in your computer for future use and restore the router to the previous settings from the backup file when needed.

1. Visit <http://tplinkwifi.net>, and log in with the password you set for the router.
2. Go to [System > Backup & Restore](#).

- **To backup configuration settings:**

Click **BACK UP** to save a copy of the current settings in your local computer. A ".bin" file of the current settings will be stored in your computer.

- **To restore configuration settings:**

1. Click **BROWSE** to locate the backup configuration file stored in your computer, and click **RESTORE**.
2. Wait a few minutes for the restoring and rebooting.

- **To reset the router to factory default settings:**

1. Click **FACTORY RESTORE** to reset the router.



Factory Default Restore
Restore all settings to default values.

FACTORY RESTORE

2. Wait a few minutes for the restoring and rebooting.

Note:

- During the resetting process, do not turn off or reset the router.
- We strongly recommend you backup the current configuration settings before resetting the router.

6. 4. Administration

6. 4. 1. Change Password

1. Visit <http://tplinkwifi.net>, and log in with the password you set for the router.
2. Go to **System > Administration**, and focus on the **Change Password** section.

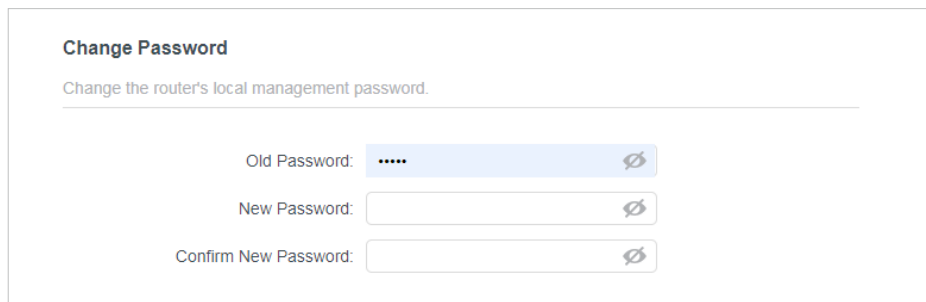

Change Password
Change the router's local management password.

Old Password: 

New Password: 

Confirm New Password: 

3. Enter the old password, then a new password twice (both case-sensitive). Click **SAVE**.
4. Use the new password for future logins.

6. 4. 2. Local Management

1. Visit <http://tplinkwifi.net>, and log in with the password you set for the router.
2. Go to **System > Administration**, and focus on the **Local Management** section.

- **Allow all LAN connected devices to manage the router:**

Select **All Devices** for **Local Managers**.

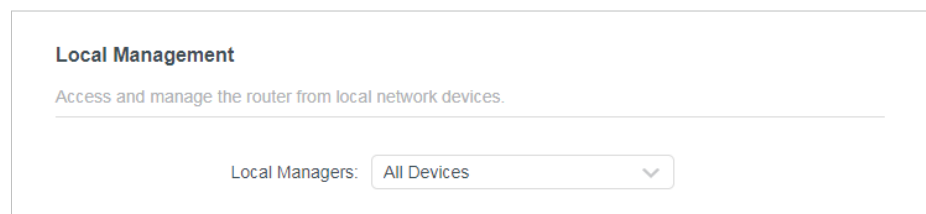

Local Management
Access and manage the router from local network devices.

Local Managers: 

- **Allow specific devices to manage the router:**

1. Select **All Devices** for **Local Managers** and click **SAVE**.

Local Management
Access and manage the router from local network devices.

Local Managers:

[+ Add Device](#)

Description	MAC Address	Operation
No Entries in this table.		

2. Click **Add Device**.

Add Device [X]

Description:

[VIEW CONNECTED DEVICES](#)

MAC Address:

[CANCEL](#) [SAVE](#)

3. Click **VIEW CONNECTED DEVICES** and select the device to manage the router from the Connected Devices list, or enter the MAC address of the device manually.

4. Specify a **Description** for this entry.

5. Click **SAVE**.

6. 5. System Log

1. Visit <http://tplinkwifi.net>, and log in with the password you set for the router.

2. Go to **System > System Log**, and you can view the logs of the router.

System Log

View a detailed record of system activities.

Current Time: 2019-09-02 09:21:46

Refresh
Clear All

```

1 WARNING 0days, 00:00:00, Invalid lan mac, now start by default mac 00-19-66-CA-8B-07.
2 INFO 0days, 00:00:00, LAN: Attach mirror0 to stack.
3 INFO 0days, 00:00:00, LAN: Set interface mirror0 ip=192.168.0.1 netmask 255.255.255.0.
4 INFO 0days, 00:00:00, HTTPD: Http server start!
5 INFO 0days, 00:00:05, WAN: Attach interface eth1.
6 INFO 0days, 00:00:07, WAN: Wan ethernet port plug on.
7 INFO 0days, 00:00:08, DHCPD: Send DISCOVER with unicast flag 0.
8 INFO 0days, 00:00:08, DHCPD: Recv OFFER from server 10.0.0.1 with ip 10.0.2.225.
9 INFO 0days, 00:00:08, DHCPD: Send REQUEST to server 10.0.0.1 with request ip 10.0.2.225.
10 INFO 0days, 00:00:08, DHCPD: eth1 set ip 10.0.2.225 mask 255.255.252.0 gateway 10.0.0.1.
11 INFO 0days, 00:00:08, WAN: advanced odns -wanChanged
12 INFO 0days, 00:07:26, DHCPD: Send ACK to 192.168.0.101.

```

Save Log

Save system log locally.

SAVE TO LOCAL

3. Click **SAVE TO LOCAL** to save the system logs to a local disk.

6.6. Time Settings

This page allows you to set the time manually or to configure automatic time synchronization. The router can automatically update the time from an NTP server via the internet.

1. Visit <http://tplinkwifi.net>, and log in with the password you set for the router.
2. Go to **System > Time**.

- **To set System Time:**

System Time

Set the router's system time.

Current Time: 2019-09-02 09:22:39

24-Hour Time:

Set Time: Get from Internet

Time Zone: (GMT+00:00) Greenwich Mean Time: Dublin, I

NTP Server I:

NTP Server II: (Optional)

1. Select the way in which the router gets its time: Get from Internet, Get from Managing Device, Manually.
2. Select your local [Time Zone](#).
3. Enter the address or domain of the [NTP Server 1](#) or [NTP Server 2](#).
4. Click [SAVE](#).

- **To set up Daylight Saving Time:**

1. Select [Enable Daylight Saving](#).

Daylight Saving Time

Automatically synchronize the system time with daylight saving time.

Daylight Saving Time: Enable

Start: 2019

End: 2019

Running Status: Daylight Saving Time is off.

2. Select the start time from the drop-down list in the [Start](#) fields.
3. Select the end time from the drop-down list in the [End](#) fields.
4. Click [SAVE](#).

Note:

This setting will be used for some time-based functions such as firewall. You must specify your time zone once you log in to the router successfully; otherwise, time-based functions will not take effect.

6.7. Reboot

Some settings of the router will take effect only after rebooting, and the system will reboot automatically. You can also reboot the router to clear cache and enhance running performance.

1. Visit <http://tplinkwifi.net>, and log in with the password you set for the router.
2. Go to [System](#) > [Reboot](#), and you can restart your router.

- **To reboot the router manually:**

Click [REBOOT](#), and wait a few minutes for the router to reboot.

Reboot

Reboot to clear cache and enhance running performance.

[REBOOT](#)

- **To set the router to reboot regularly:**

1. Tick the **Enable** box of **Reboot Schedule**.
2. Specify the **Reboot Time** when the router reboots and **Repeat** to decide how often it reboots.
3. Click **SAVE**.

Reboot Schedule
Set when and how often the router reboots automatically.

Reboot Schedule: Enable

Note: Make sure [Time Settings](#) are correct before using this function.

Current Time: 2019-09-02 09:23:51

Reboot Time: 00 : 00

Repeat: Every Day

6.8. LED Control

The LED of the router indicates its activities and status. You can enable the Night Mode feature to specify a time period during which the LED is off.

1. Visit <http://tplinkwifi.net>, and log in with the password you set for the router.
2. Go to **System > LED Control**.
3. Enable **Night Mode**.

LED Control
Turn the router's LEDs on or off.

LED Status:

Night Mode
Set a time period when the LEDs will be off automatically.

Night Mode: Enable

Note: Make sure [Time Settings](#) are correct before using this function.

Current Time: 2019-09-02 09:24:35

LED Off From: 23 : 00

To: 06 : 00 (next day)

4. Specify the LED off time, and the LED will be off during this period every day.

Note: The effective LED off time is based on the time of the router. You can go to [Advanced](#) > [System](#) > [Time & Language](#) to modify the time.

5. Click **SAVE**.

FAQ

Q1. What should I do if I forget my wireless password?

The default wireless password is printed on the label of the router. If the password has been altered, please connect your computer to the router using an Ethernet cable and follow the steps below:

1. Visit <http://tplinkwifi.net>, and log in with the password you set for the router.
2. Go to [Wireless](#) or [Advanced > Wireless > Wireless Settings](#) or to retrieve or reset your wireless password.

Q2. What should I do if I forget my login password of the web management page?

1. Reset the router to its factory default settings.
2. Visit <http://tplinkwifi.net>, and create a password for future login.

Note: You'll need to reconfigure the router to surf the Internet once the router is reset, and please mark down your new password for future use.

Q3. What should I do if I cannot log in to the router's web management page?

This can happen for a variety of reasons. Please try the methods below to log in again.

- Make sure your computer has connected to the router correctly and the corresponding LED light up.
- Make sure the IP address of your computer is configured as [Obtain an IP address automatically](#) and [Obtain DNS server address automatically](#).
- Make sure you enter the correct IP address to log in: <http://tplinkwifi.net> or 192.168.0.1.
- Check your computer's settings:
 - 1) Go to [Start > Control Panel > Network and Internet](#), and click [View network status and tasks](#).
 - 2) Click [Internet Options](#) on the bottom left.
 - 3) Click [Connections](#) and select [Never dial a connection](#).

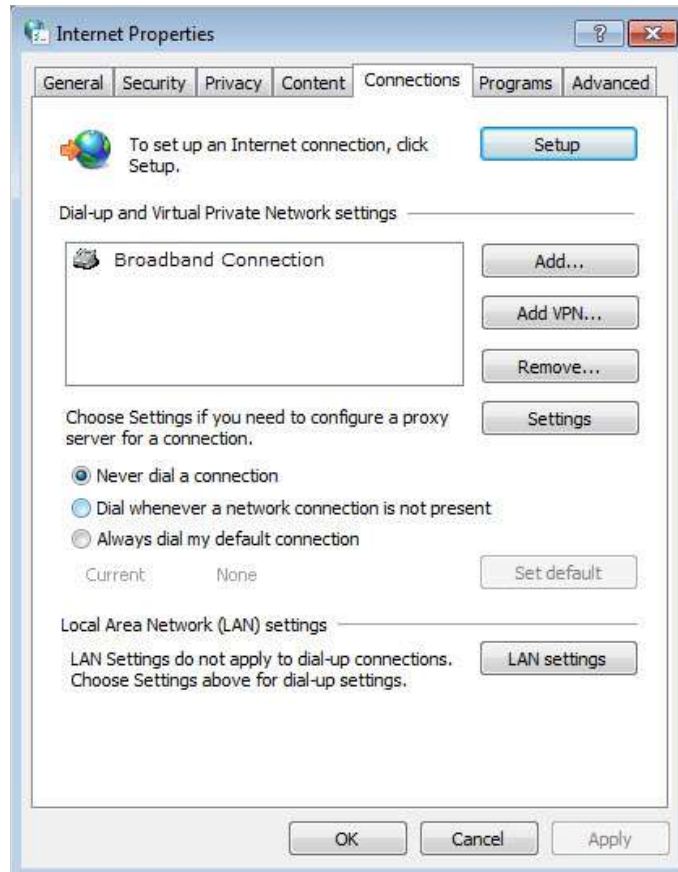

4) Click [LAN settings](#) and deselect the following three options, and click [OK](#).



5) Go to [Advanced](#) > [Restore advanced settings](#), and click [OK](#).

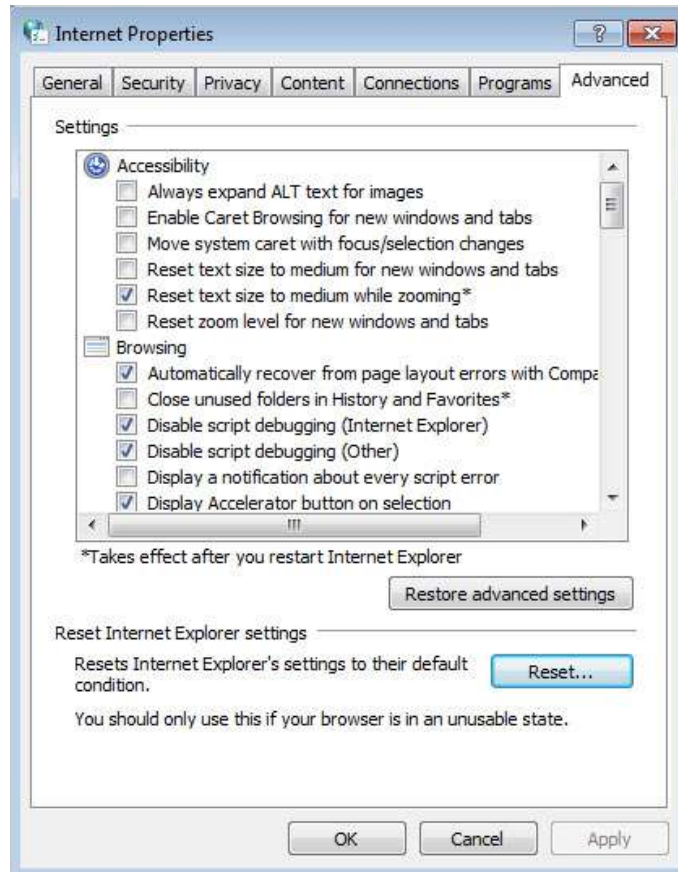

- Use another web browser or computer to log in again.
- Reset the router to factory default settings and try again. If the login still fails, please contact the technical support.
 - Note: You'll need to reconfigure the router to surf the internet once the router is reset.

Q4. What should I do if I cannot access the internet even though the configuration is finished?

1. Visit <http://tplinkwifi.net>, and log in to with the password you set for the router.
2. Go to **Advanced > Network > Status** to check the Internet status:

If IP Address is a valid one, please try the methods below and try again:

- Your computer might not recognize any DNS server addresses, please manually configure DNS server.
 - 1) Go to **Advanced > Network > DHCP Server**.
 - 2) Enter 8.8.8.8 as Primary DNS, and click **Save**.

🔗 Tips: 8.8.8.8 is a safe and public DNS server operated by Google.

DHCP Server

Dynamically assign IP addresses to the devices connected to the router.

DHCP Server: Enable

IP Address Pool: -

Address Lease Time: minutes

Default Gateway: (Optional)

Primary DNS: (Optional)

Secondary DNS: (Optional)

- Restart the modem and the router.
 - 1) Power off your modem and the router, and leave them off for 1 minute.
 - 2) Power on your modem first, and wait about 2 minutes.
 - 3) Power on the router, and wait another 1 or 2 minutes and check the Internet access.
- Reset the router to factory default settings and reconfigure the router.
- Upgrade the firmware of the router.
- Check the TCP/IP settings on the particular device if all other devices can get internet from the router.

If the IP Address is 0.0.0.0, please try the methods below and try again:

- Make sure the physical connection between the router and the modem is proper.
- Clone the MAC address of your computer.
 - 1) Visit <http://tplinkwifi.net>, and log in with the username and password you set for the router.
 - 2) Go to **Advanced > Network > Internet**, select **Clone Current Device MAC** and click **SAVE**.

MAC Clone

Router MAC Address:

Use Default MAC Address

Clone Current Device MAC

Use Custom MAC Address

NAT

Tips:

- Some ISP will register the MAC address of your computer when you access the Internet for the first time through their Cable modem, if you add a router into your network to share your Internet connection, the ISP will not accept it as the MAC address is changed, so we need to clone your computer's MAC address to the router.

- The MAC addresses of a computer in wired connection and wireless connection are different.

- **Modify the LAN IP address of the router.**

Note:

Most TP-Link routers use 192.168.0.1/192.168.1.1 as their default LAN IP address, it may conflict with the IP range of your existent ADSL modem/router. If so, the router is not able to communicate with your modem and cause you can't access the Internet. To resolve this problem, we need to change the LAN IP address of the router to avoid such conflict, for example, 192.168.2.1.

- 1) Visit <http://tplinkwifi.net>, and log in with the username and password you set for the router.
- 2) Go to **Advanced > Network > LAN**.
- 3) Modify the LAN IP address as the follow picture shows. Here we take 192.168.2.1 as an example.
- 4) Click **Save**.

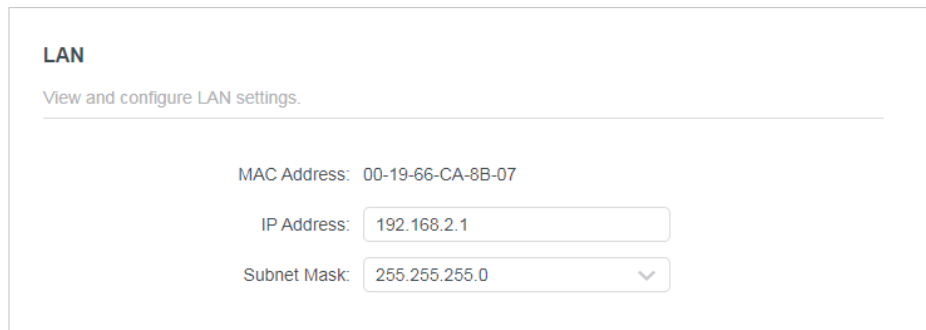

LAN
View and configure LAN settings.

MAC Address: 00-19-66-CA-8B-07

IP Address:

Subnet Mask:

- **Restart the modem and the router.**

- 1) Power off your modem and the router, and leave them off for 1 minute.
- 2) Power on your modem first, and wait about 2 minutes.
- 3) Power on the router, and wait another 1 or 2 minutes and check the internet access.

- **Double check the Internet Connection Type.**

- 1) Confirm your Internet Connection Type, which can be learned from the ISP.
- 2) Visit <http://tplinkwifi.net>, and log in with the username and password you set for the router.
- 3) Go to **Advanced > Network > WAN**.
- 4) Select your **Internet Connection Type** and fill in other parameters.
- 5) Click **SAVE**.

Internet

Set up an internet connection with the service information provided by your ISP (internet service provider).

Internet Connection Type:

IP Address: 10.0.2.224

Subnet Mask: 255.255.252.0

Default Gateway: 10.0.0.1

Primary DNS: 10.0.0.1

Secondary DNS: 0.0.0.0

[Advanced Settings](#)

DNS Address:

Primary DNS: 10.0.0.1

Secondary DNS: 0.0.0.0

MTU Size: bytes

The default is 1500, do not change unless necessary.

Host Name:

Get IP with Unicast DHCP

6) Restart the modem and the router.

- Please upgrade the firmware of the router.

If you've tried every method above but cannot access the internet, please contact the technical support.

Q5. What should I do if I cannot find my wireless network or I cannot connect to the wireless network?

If you fail to find any wireless network, please follow the steps below:

- Make sure the wireless function of your device is enabled if you're using a laptop with a built-in wireless adapter. You can refer to the relevant document or contact the laptop manufacturer.
- Make sure the wireless adapter driver is installed successfully and the wireless adapter is enabled.
 - **On Windows 7**
 - 1) If you see the message [No connections are available](#), it is usually because the wireless function is disabled or blocked somehow.
 - 2) Clicking [Troubleshoot](#) and windows might be able to fix the problem by itself.
 - **On Windows XP**

- 1) If you see the message [Windows cannot configure this wireless connection](#), this is usually because windows configuration utility is disabled or you are running another wireless configuration tool to connect the wireless.
- 2) Exit the wireless configuration tool (the TP-Link Utility, for example).
- 3) Select and right click [My Computer](#) on Desktop, and select [Manage](#) to open Computer Management window.
- 4) Expand [Services and Applications](#) > [Services](#), and find and locate [Wireless Zero Configuration](#) in the Services list on the right side.
- 5) Right click [Wireless Zero Configuration](#), and then select [Properties](#).
- 6) Change [Startup type](#) to [Automatic](#), click [Start](#) and make sure the Service status is [Started](#). And then click [OK](#).

If you can find other wireless network except your own, please follow the steps below:

- Make sure your computer/device is still in the range of your router/modem. Move closer if it is currently too far away.

If you can find your wireless network but fail to connect, please follow the steps below:

- **Authenticating problem/password mismatch:**

- 1) Sometimes you will be asked to type in a PIN number when you connect to the wireless network for the first time. This PIN number is different from the Wireless Password/Network Security Key. Usually you can only find it on the label of your router.



- 2) If you cannot find the PIN or PIN failed, you may choose [Connecting using a security key instead](#), and then type in the [Wireless Password/Network Security Key](#).
- 3) If it continues to show note of [Network Security Key Mismatch](#), it is suggested to confirm the wireless password of your wireless router.

■ **Note:** Wireless Password/Network Security Key is case sensitive.

- **Windows unable to connect to XXXX / Can not join this network / Taking longer than usual to connect to this network:**
 - Check the wireless signal strength of your network, if it is weak (1~3 bars), please move the router closer and try again.
 - Change the wireless Channel of the router to 1,6,or 11 to reduce interference from other networks.
 - Re-install or update the driver for your wireless adapter of the computer.

COPYRIGHT & TRADEMARKS

Specifications are subject to change without notice.  tp-link is a registered trademark of TP-Link Technologies Co., Ltd. Other brands and product names are trademarks or registered trademarks of their respective holders.

No part of the specifications may be reproduced in any form or by any means or used to make any derivative such as translation, transformation, or adaptation without permission from TP-Link Technologies Co., Ltd. Copyright © 2020 TP-Link Technologies Co., Ltd. All rights reserved.

FCC compliance information statement



Product Name: AC750 Dual Band Wi-Fi Router

Model Number: Archer C24

Component Name	Model
I.T.E. Power	T090060-2B1

Responsible party:

TP-Link USA Corporation, d/b/a TP-Link North America, Inc.

Address: 145 South State College Blvd. Suite 400, Brea, CA 92821

Website: <http://www.tp-link.com/us/>

Tel: +1 626 333 0234

Fax: +1 909 527 6803

E-mail: sales.usa@tp-link.com

This equipment has been tested and found to comply with the limits for a Class B digital device, pursuant to part 15 of the FCC Rules. These limits are designed to provide reasonable protection against harmful interference in a residential installation. This equipment generates, uses and can radiate radio frequency energy and, if not installed and used in accordance with the instructions, may cause harmful interference to radio communications. However, there is no guarantee that interference will not occur in a particular installation. If this equipment does cause harmful interference to radio or television reception, which can be determined by turning the equipment off and on, the user is encouraged to try to correct the interference by one or more of the following measures:

- Reorient or relocate the receiving antenna.
- Increase the separation between the equipment and receiver.
- Connect the equipment into an outlet on a circuit different from that to which the receiver is connected.
- Consult the dealer or an experienced radio/ TV technician for help.

This device complies with part 15 of the FCC Rules. Operation is subject to the following two conditions:

1. This device may not cause harmful interference.
2. This device must accept any interference received, including interference that may cause undesired operation.

Any changes or modifications not expressly approved by the party responsible for compliance could void the user's authority to operate the equipment.

Note: The manufacturer is not responsible for any radio or TV interference caused by unauthorized modifications to this equipment. Such modifications could void the user's authority to operate the equipment.

FCC RF Radiation Exposure Statement

This equipment complies with FCC RF radiation exposure limits set forth for an uncontrolled environment. This device and its antenna must not be co-located or operating in conjunction with any other antenna or transmitter.

"To comply with FCC RF exposure compliance requirements, this grant is applicable to only Mobile Configurations. The antennas used for this transmitter must be installed to provide a separation distance of at least 20 cm from all persons and must not be co-located or operating in conjunction with any other antenna or transmitter."

We, **TP-Link USA Corporation**, has determined that the equipment shown as above has been shown to comply with the applicable technical standards, FCC part 15. There is no unauthorized change is made in the equipment and the equipment is properly maintained and operated.

Issue Date: 2020-06-28

FCC compliance information statement

Product Name: I.T.E. Power Supply

Model Number: T090060-2B1

Responsible party:

TP-Link USA Corporation, d/b/a TP-Link North America, Inc.

Address: 145 South State College Blvd. Suite 400, Brea, CA 92821

Website: <http://www.tp-link.com/us/>

Tel: +1 626 333 0234

Fax: +1 909 527 6803

E-mail: sales.usa@tp-link.com

This equipment has been tested and found to comply with the limits for a Class B digital device, pursuant to part 15 of the FCC Rules. These limits are designed to provide reasonable protection against harmful interference in a residential installation. This equipment generates, uses and can radiate radio frequency energy and, if not installed and used in accordance with the instructions, may cause harmful interference to radio communications. However, there is no guarantee that interference will not occur in a particular installation. If this equipment does cause harmful interference to radio or television reception, which can be determined by turning the equipment off and on, the user is encouraged to try to correct the interference by one or more of the following measures:

- Reorient or relocate the receiving antenna.
- Increase the separation between the equipment and receiver.
- Connect the equipment into an outlet on a circuit different from that to which the receiver is connected.
- Consult the dealer or an experienced radio/ TV technician for help.

This device complies with part 15 of the FCC Rules. Operation is subject to the following two conditions:

1. This device may not cause harmful interference.
2. This device must accept any interference received, including interference that may cause undesired operation.

Any changes or modifications not expressly approved by the party responsible for compliance could void the user's authority to operate the equipment.

We, **TP-Link USA Corporation**, has determined that the equipment shown as above has been shown to comply with the applicable technical standards, FCC part 15. There is no unauthorized change is made in the equipment and the equipment is properly maintained and operated.

Issue Date: 2020-06-28

CE Mark Warning



This is a class B product. In a domestic environment, this product may cause radio interference, in which case the user may be required to take adequate measures.

OPERATING FREQUENCY (the maximum transmitted power)

2400 MHz -2483.5 MHz (20dBm)

5150 MHz -5250 MHz(23dBm)

EU Declaration of Conformity

TP-Link hereby declares that the device is in compliance with the essential requirements and other relevant provisions of directives 2014/53/EU, 2009/125/EC, 2011/65/EU and (EU)2015/863.

The original EU declaration of conformity may be found at <https://www.tp-link.com/en/ce>

RF Exposure Information

This device meets the EU requirements (2014/53/EU Article 3.1a) on the limitation of exposure of the general public to electromagnetic fields by way of health protection.

The device complies with RF specifications when the device used at 20 cm from your body.

Industry Canada Statement

CAN ICES-3 (B)/NMB-3(B)

Korea Warning Statements:

당해 무선설비는 운용중 전파혼신 가능성이 있음.

National Restrictions

Attention: This device may only be used indoors in all EU member states and EFTA countries.

	AT	BE	BG	CH	CY	CZ	DE	DK
	EE	EL	ES	FI	FR	HR	HU	IE
	IS	IT	LI	LT	LU	LV	MT	NL
	NO	PL	PT	RO	SE	SI	SK	UK

Canadian Compliance Statement

This device contains licence-exempt transmitter(s)/receiver(s) that comply with Innovation, Science and Economic Development Canada's licence-exempt RSS(s). Operation is subject to the following two conditions:

- (1) This device may not cause interference.
- (2) This device must accept any interference, including interference that may cause undesired operation of the device.

L'émetteur/récepteur exempt de licence contenu dans le présent appareil est conforme aux CNR d'Innovation, Sciences et Développement économique Canada applicables aux appareils radio exempts de licence. L'exploitation est autorisée aux deux conditions suivantes :

- 1) L'appareil ne doit pas produire de brouillage;
- 2) L'appareil doit accepter tout brouillage radioélectrique subi, même si le brouillage est susceptible d'en compromettre le fonctionnement.

Caution:

1. The device for operation in the band 5150–5250 MHz is only for indoor use to reduce the potential for harmful interference to co-channel mobile satellite systems;

Avertissement:

1. Le dispositif fonctionnant dans la bande 5150-5250 MHz est réservé uniquement pour une utilisation à l'intérieur afin de réduire les risques de brouillage préjudiciable aux systèmes de satellites mobiles utilisant les mêmes canaux;

Radiation Exposure Statement:

This equipment complies with IC radiation exposure limits set forth for an uncontrolled environment. This equipment should be installed and operated with minimum distance 20cm between the radiator & your body.

Déclaration d'exposition aux radiations:

Cet équipement est conforme aux limites d'exposition aux rayonnements IC établies pour un environnement non contrôlé. Cet équipement doit être

installé et utilisé avec un minimum de 20 cm de distance entre la source de rayonnement et votre corps.

NCC Notice & BSMI Notice:

注意!

依據 低功率電波輻射性電機管理辦法

第十二條 經型式認證合格之低功率射頻電機，非經許可，公司、商號或使用者均不得擅自變更頻率、加大功率或變更原設計之特性或功能。

第十四條 低功率射頻電機之使用不得影響飛航安全及干擾合法通信；經發現有干擾現象時，應立即停用，並改善至無干擾時方得繼續使用。前項合法通信，指依電信規定作業之無線電信。低功率射頻電機需忍受合法通信或工業、科學以及醫療用電波輻射性電機設備之干擾。

4.7.9.1應避免影響附近雷達系統之操作。

4.7.9.2高增益指向性天線只得應用於固定式點對點系統。

安全諮詢及注意事項

- 請使用原裝電源供應器或只能按照本產品注明的電源類型使用本產品。
- 清潔本產品之前請先拔掉電源線。請勿使用液體、噴霧清潔劑或濕布進行清潔。
- 注意防潮，請勿將水或其他液體潑灑到本產品上。
- 插槽與開口供通風使用，以確保本產品的操作可靠並防止過熱，請勿堵塞或覆蓋開口。
- 請勿將本產品置放於靠近熱源的地方。除非有正常的通風，否則不可放在密閉位置中。
- 請不要私自拆開機殼或自行維修，如產品有故障請與原廠或代理商聯繫。

設備名稱：AC750 Dual Band Wi-Fi Router Equipment name			型號（型式）：Archer C24 Type designation (Type)			
單元 Unit	限用物質及其化學符號 Restricted substances and its chemical symbols					
	鉛 Lead (Pb)	汞 Mercury (Hg)	鎘 Cadmium (Cd)	六價鉻 Hexavalent chromium (Cr ⁺⁶)	多溴聯苯 Polybrominated biphenyls (PBB)	多溴二苯醚 Polybrominated diphenyl ethers (PBDE)
PCB	○	○	○	○	○	○
外殼	○	○	○	○	○	○
電源供應器	—	○	○	○	○	○
天線	○	○	○	○	○	○
備考 1. “超出 0.1 wt %” 及 “超出 0.01 wt %” 係指限用物質之百分比含量超出百分比含量基準值 Note 1: “Exceeding 0.1 wt %” and “exceeding 0.01 wt %” indicate that the percentage content of the restricted substance exceeds the reference percentage value of presence condition. 備考 2. “○” 係指該項限用物質之百分比含量未超出百分比含量基準值。 Note 2: “○” indicates that the percentage content of the restricted substance does not exceed the percentage of reference value of presence. 備考 3. “—” 係指該項限用物質為排除項目。 Note 3: The “—” indicates that the restricted substance corresponds to the exemption.						



Продукт сертифіковано згідно с правилами системи УкрСЕПРО на відповідність вимогам нормативних документів та вимогам, що передбачені чинними законодавчими актами України.



Safety Information

- Keep the device away from water, fire, humidity or hot environments.
- Do not attempt to disassemble, repair, or modify the device. If you need service, please contact us.
- Do not use damaged charger or USB cable to charge the device.
- Do not use any other chargers than those recommended
- Do not use the device where wireless devices are not allowed.
- Adapter shall be installed near the equipment and shall be easily accessible.
- Use only power supplies which are provided by manufacturer and in the original packing of this product. If you have any questions, please don't hesitate to contact us.

Please read and follow the above safety information when operating the device. We cannot guarantee that no accidents or damage will occur due to improper use of the device. Please use this product with care and operate at your own risk.

Explanations of the symbols on the product label

Symbol	Explanation
	Alternating current
	Class II equipment
	Polarity of d.c. power connector
	Energy efficiency Marking
	DC voltage
	Indoor use only
	Operator's manual
	RECYCLING This product bears the selective sorting symbol for Waste electrical and electronic equipment (WEEE). This means that this product must be handled pursuant to European directive 2012/19/EU in order to be recycled or dismantled to minimize its impact on the environment. User has the choice to give his product to a competent recycling organization or to the retailer when he buys a new electrical or electronic equipment.